



This is a digital copy of a book that was preserved for generations on library shelves before it was carefully scanned by Google as part of a project to make the world's books discoverable online.

It has survived long enough for the copyright to expire and the book to enter the public domain. A public domain book is one that was never subject to copyright or whose legal copyright term has expired. Whether a book is in the public domain may vary country to country. Public domain books are our gateways to the past, representing a wealth of history, culture and knowledge that's often difficult to discover.

Marks, notations and other marginalia present in the original volume will appear in this file - a reminder of this book's long journey from the publisher to a library and finally to you.

Usage guidelines

Google is proud to partner with libraries to digitize public domain materials and make them widely accessible. Public domain books belong to the public and we are merely their custodians. Nevertheless, this work is expensive, so in order to keep providing this resource, we have taken steps to prevent abuse by commercial parties, including placing technical restrictions on automated querying.

We also ask that you:

- + *Make non-commercial use of the files* We designed Google Book Search for use by individuals, and we request that you use these files for personal, non-commercial purposes.
- + *Refrain from automated querying* Do not send automated queries of any sort to Google's system: If you are conducting research on machine translation, optical character recognition or other areas where access to a large amount of text is helpful, please contact us. We encourage the use of public domain materials for these purposes and may be able to help.
- + *Maintain attribution* The Google "watermark" you see on each file is essential for informing people about this project and helping them find additional materials through Google Book Search. Please do not remove it.
- + *Keep it legal* Whatever your use, remember that you are responsible for ensuring that what you are doing is legal. Do not assume that just because we believe a book is in the public domain for users in the United States, that the work is also in the public domain for users in other countries. Whether a book is still in copyright varies from country to country, and we can't offer guidance on whether any specific use of any specific book is allowed. Please do not assume that a book's appearance in Google Book Search means it can be used in any manner anywhere in the world. Copyright infringement liability can be quite severe.

About Google Book Search

Google's mission is to organize the world's information and to make it universally accessible and useful. Google Book Search helps readers discover the world's books while helping authors and publishers reach new audiences. You can search through the full text of this book on the web at <http://books.google.com/>

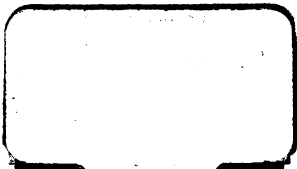
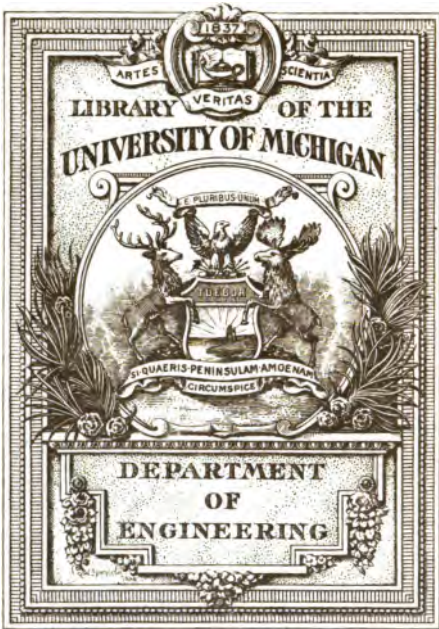

TJ
860
G57

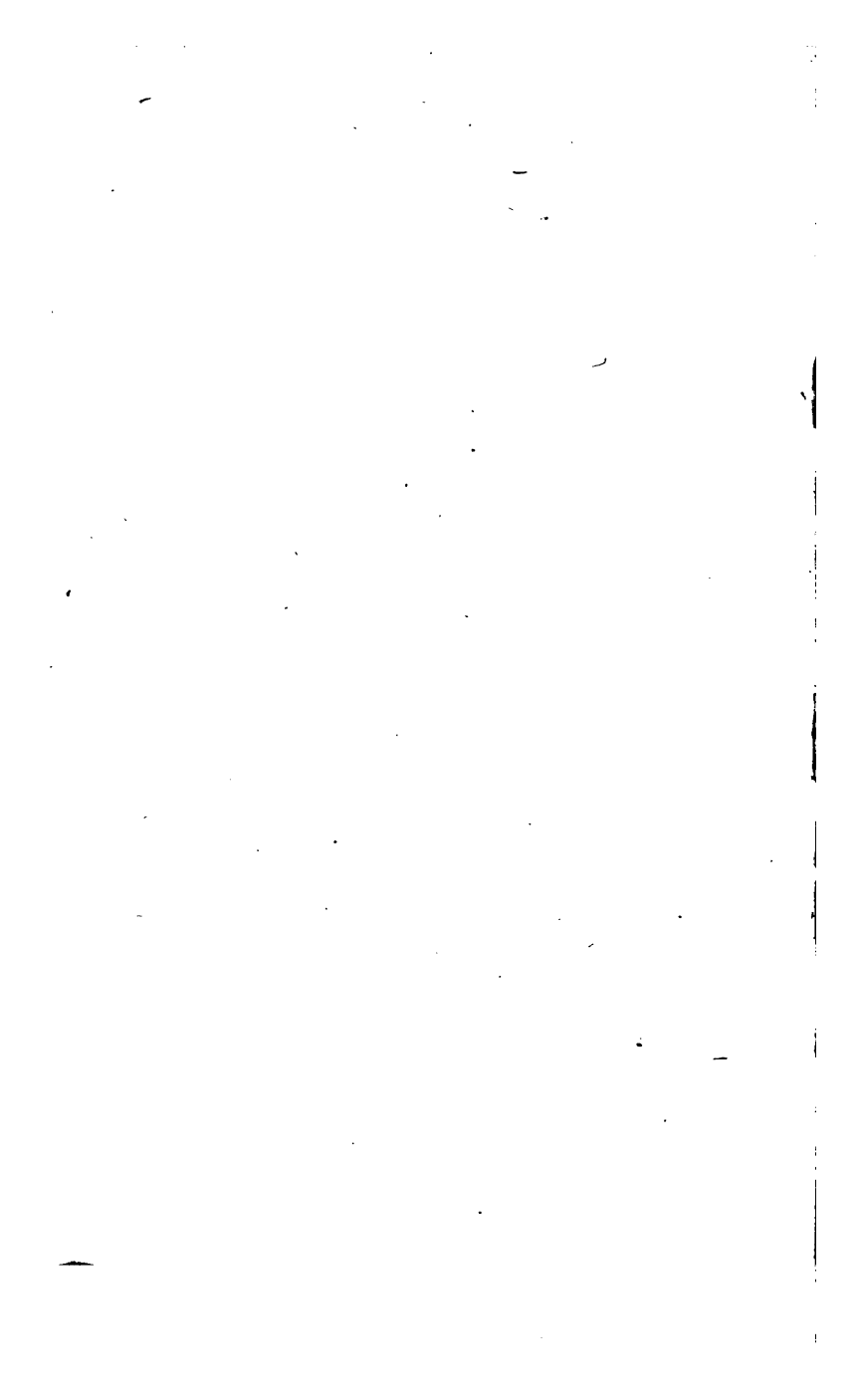



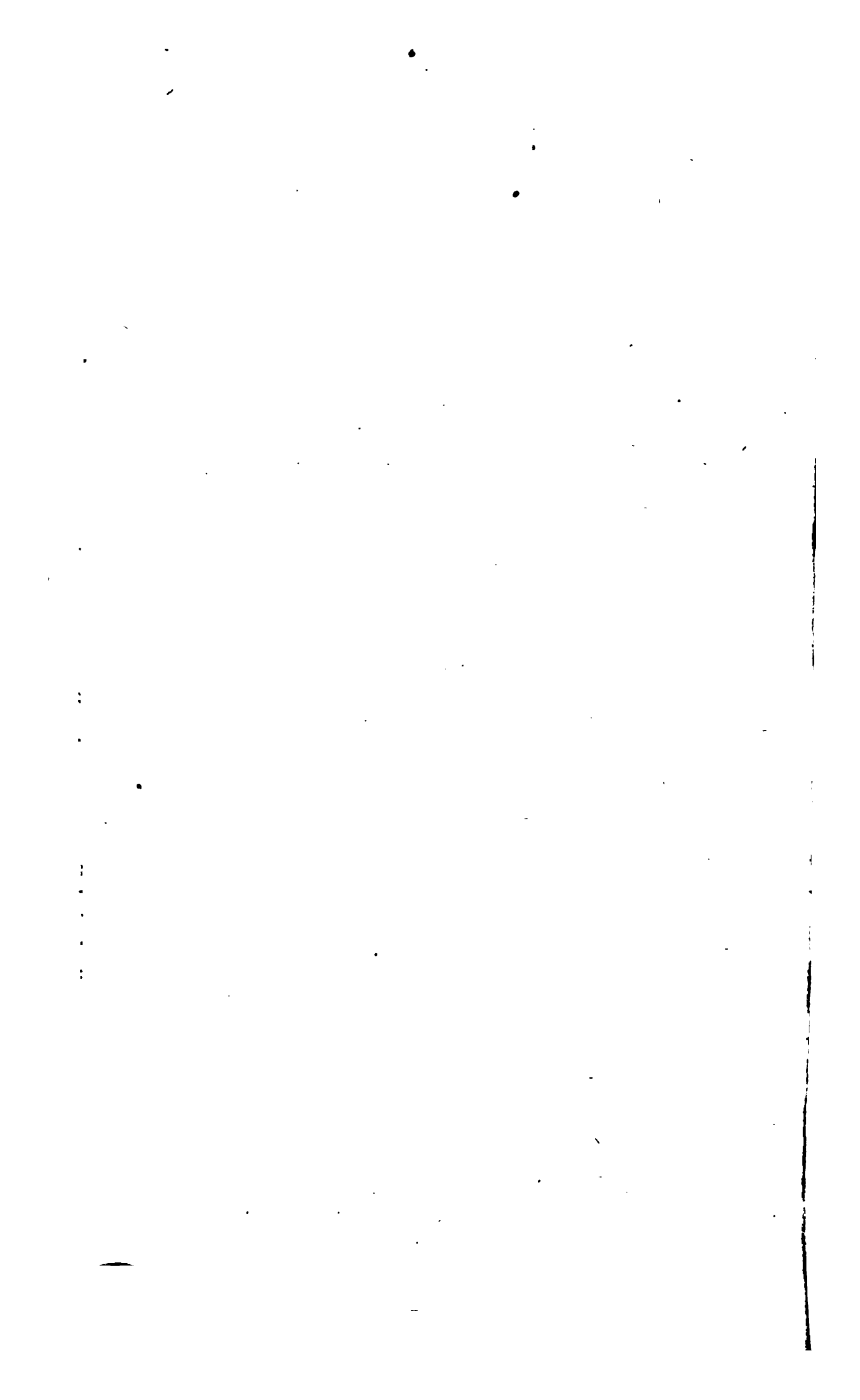

RUDIMENTARY TREATISE

ON

THE POWER OF WATER.

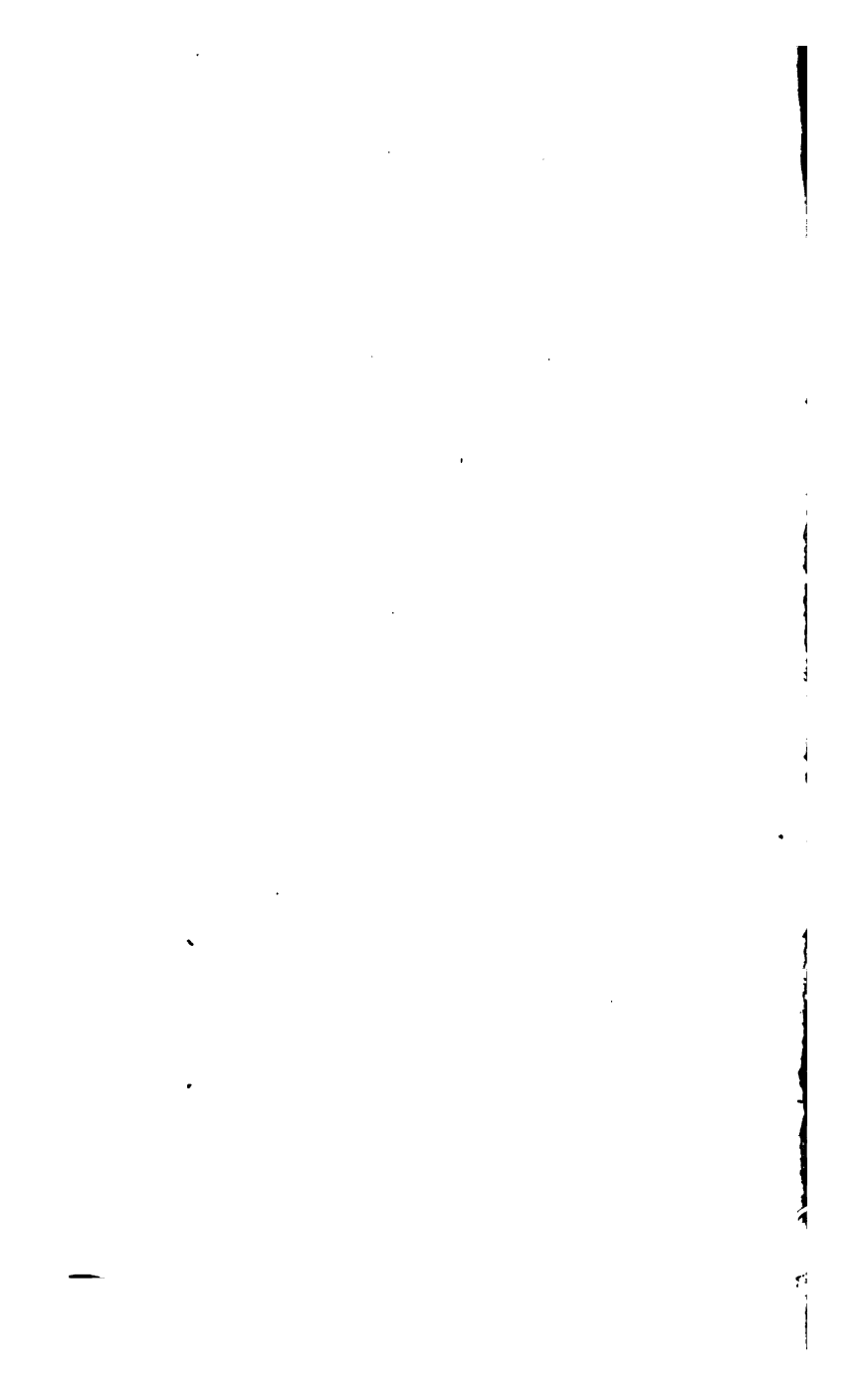

21.11.11

RUDIMENTARY TREATISE

ON THE

POWER OF WATER.

AS APPLIED TO DRIVE FLOUR MILLS, AND TO GIVE MOTION TO
TURBINES AND OTHER HYDROSTATIC ENGINES.

BY

JOSEPH GLYNN, F.R.S.

Member of the Institution of Civil Engineers, &c. Honorary Member of the Philosophical
Society, Newcastle-upon-Tyne, etc.

WITH ILLUSTRATIONS,
AND
AN APPENDIX ON CENTRIFUGAL AND ROTARY PUMPS.

LONDON:
JOHN WEALE, 59, HIGH HOLBORN.
1853.

LONDON:
BRADBURY AND EVANS, PRINTERS, WHITEFRIARS.

09 Rec! 6-27-38 r. E. W.

TO THE RIGHT HONOURABLE

THE EARL OF ROSSE, K.P.

PRESIDENT OF THE ROYAL SOCIETY.

This Book

IS MOST RESPECTFULLY DEDICATED.

4963

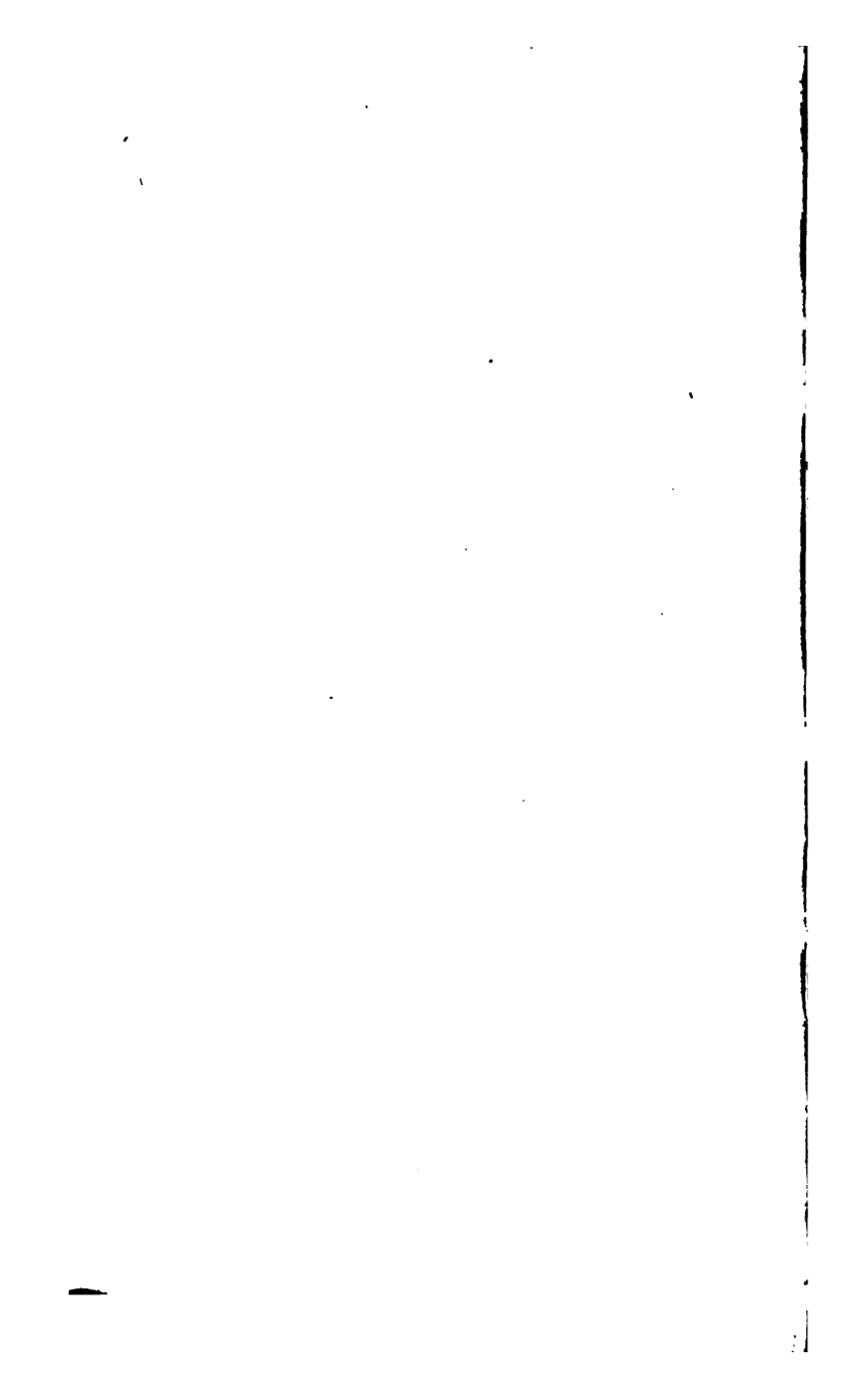

PREFACE.

SOME of the most pleasant days of the author's early life were passed on a small, but picturesque estate belonging to his family, on which were three corn mills—one driven by wind, and two by water. To his youthful associations with these and their tenants may in part be owing his attachment to mechanical pursuits. Subsequently his father was induced, as an investment, to build, on other property, a flour-mill driven by steam, to which, during its erection, he was a daily visitor.

In after life his professional employment as a civil engineer frequently involved the construction of water-wheels, many of them on a large scale, for drainage and irrigation, and for motive power, besides hydraulic works of various kinds.

Few persons have had occasion to use the steam-engine more extensively, and he is fully sensible of its great value and importance as a prime mover for machinery; yet he has often felt that water-power has been unduly superseded or neglected when it might have been usefully employed; there are many places where fuel is scarce, where water abounds, and where mechanical power is wanted, but much expense cannot be afforded; and if motive power be used at all, it must be obtained at light cost.

In such circumstances are some of the colonies, and many parts of Ireland: there water-power must precede the steam-engine and be the pioneer to manufacturing industry.

He has often contemplated writing some short and popular work on this subject, whenever an opportunity might present itself: this has now occurred in the publication of a series of rudimentary books by Mr. Weale; and having already written one of these, a "Rudimentary Treatise on Cranes," which has circulated very extensively, and been translated into several foreign languages, he has been induced to devote such intervals of leisure as he could obtain to the production of the present volume.

It is with much satisfaction he inscribes this Rudimentary Treatise on Water Power to the Earl of Rosse; not only from his lordship's well-known attachment to science, but from his practical knowledge and skill in the mechanical arts, and his zeal for the benefit and improvement of his country. It will be most gratifying to the author if this little book contribute in any way to extend the employment of a power which Ireland so largely possesses, or to aid in advancing the progress of manufacturing industry in the sister island.

J. G.

London, December, 1852.

CONTENTS.

	Page
PREFACE	vii
CHAPTER I.	
ON THE EARLY USE OF MILL-STONES TO GRIND CORN, AND THE EMPLOYMENT OF WATER AS A MOVING POWER	1
CHAPTER II.	
ON THE NATURE AND PROPERTIES OF WATER, AS THEY RELATE TO THE SUBJECT OF THIS BOOK	10
CHAPTER III.	
ON THE MEASUREMENT OF EFFLUENT WATER	16
CHAPTER IV.	
THE SOURCES AND SUPPLY OF WATER, ITS DISTRIBUTION AND USE AS A MOTIVE POWER	25
CHAPTER V.	
RAIN GAUGES, RESERVOIRS.—EMBANKMENTS AND THEIR CONSTRUCTION	30
CHAPTER VI.	
HORIZONTAL WATER-WHEELS AND SIMILAR MACHINES	37
CHAPTER VII.	
TURBINES AND THE RE-ACTION OF WATER PRESSURE ON WHEELS, &c.	50

	Page
CHAPTER VIII.	
UNDERSHOT WATER-WHEELS, THEIR USEFULNESS IN A NEW COUNTRY TO SAW TIMBER, &c.	64
CHAPTER IX.	
OVERSHOT WATER-WHEELS. THE GRAVITY OF WATER EMPLOYED INSTEAD OF IMPULSE	75
CHAPTER X.	
BREAST WHEELS; M. PONCELET'S WATER-WHEEL FOR LARGE STREAMS AND LOW FALLS	85
CHAPTER XI.	
THE WATER-PRESSURE ENGINE AND THE WATER-RAM	96
CHAPTER XII.	
THE APPLICATION OF WATER-POWER TO GRIND CORN; THE PROGRESS OF CORN MILLS AND DEVELOPMENT OF THEIR MACHINERY	117
CHAPTER XIII.	
THE CONICAL CORN MILLS. MR. SCHIELE'S CONOIDAL PIVOTS; MR. WESTRUP'S MILL—AND CONCLUSION	138
APPENDIX.	
ON CENTRIFUGAL AND ROTARY PUMPS	146

LIST OF ILLUSTRATIONS.

	Page
ORIGINAL MILL	3
PRIMITIVE WATER-MILL	4
MILL FOUND AT POMPEII	5
CHINESE WHEEL FOR IRRIGATION	9
WATER PASSING THROUGH NOTCH AND ORIFICE	19
RAIN GAUGE	34
EMBANKMENT AND DIAGRAM OF PRESSURE	35
ROUE À CUVES. ELEVATION PLAN AND BUCKETS	39
ROUET VOLANT. DO. AND VANES	40
HORIZONTAL WHEEL (DRAWING FROM GENOA)	42
SECTION OF FIXED AND MOVING PARTS	43
PLANS OF DO. DO.	44
MM. FROMONT'S WHEEL	46
DO. QUARTER PLAN AND SECTION	48
DR. BARKER'S MILL AND PLAN	51
DIAGRAM AND SECTION	53
SECTION OF DOUBLE MACHINE	54
WHITELAW'S MILL AND PLAN	55
LOW PRESSURE TURBINE AND PLAN	59
HIGH PRESSURE DO.	61
QUARTER PLAN OF DO.	62
VORTEX WHEEL AND PLAN	63
UNDERSHOT WHEEL AND AMERICAN SAW-MILL	70

	Page
JET OR IMPULSE WHEEL	74
OVERSHOT WHEEL	79
BREAST WHEEL (MR. RENNIE'S)	86
BUCKETS—AND VENTILATING DO.	88
DO. AND GOVERNOR, WALTHAM ABBEY	89
PONCELET'S WATER-WHEEL	94
PRESSURE ENGINE, ELEVATION, AND SECTION	102
PLAN OF DO.	104
DO. ARMSTRONG'S ELEVATION	107
DO. SECTION AND VALVES	110
WATER RAM MONTGOLFIER. EASTON AND AMOS	116
TWO MODES OF DRIVING MILL-STONES	119
NETHER MILL-STONE	121
GYMBAL RINGS	122
MILL-STONES DRIVEN BY BEVILLED WHEELS	126
MILL-STONES DRIVEN BY SPUR GEAR	127
MILL-STONES DRIVEN BY BELTS	128
MR. BOVILL'S MODE OF VENTILATING DO.	137
MR. SCHIELE'S CONICAL MILL AND PIVOTS	139
MR. WESTRUP'S MILL	142

RUDIMENTARY TREATISE
ON
THE POWER OF WATER.

TO TURN MILLS AND GIVE MOTION TO MACHINES.

CHAPTER I.

THE EARLY USE OF MILLSTONES TO GRIND CORN, AND THE
EMPLOYMENT OF WATER AS A MOVING POWER.

ALTHOUGH labour is the lot of man, and is indeed necessary to his existence, yet the human mind naturally revolts from those kinds of labour in which it takes no part, and in all ages men have endeavoured to shun mere toil involving only the employment of animal strength without the exercise of thought or dexterity. Thus it has ever been from the earliest ages even until now, that occupations requiring nothing beyond the exertion of muscular force have been assigned to persons taken captive in war, or sold into slavery, or reduced by other misfortunes to perform constant and monotonous labour.

Such were of old the hewers of wood and the drawers of water, and when corn was first ground to make bread, the task of turning the mill was performed by the bondman or the captive, or else among rude tribes it was imposed on the women of the family while the men were engaged in war or in the chase.

Thus we read in the book of Judges, when the Philistines heaped injury and insult on their fallen foe, "they put out

his eyes and bound him with fetters of brass, and he did grind in the prison-house."

So when the Prophet foretells the utter destruction and desolation of a great and mighty empire he says, "Come down, and sit in the dust, O virgin daughter of Babylon, sit on the ground: there is no throne, O daughter of the Chaldeans: for thou shalt no more be called tender and delicate. Take the millstones and grind meal."

The grinding of meal appears to have been performed in very remote ages by a pair of millstones, similar in form and in principle to those at present in use, the difference being chiefly in their size and in the mode of driving them. The Mosaic law says, "No man shall take the nether or the upper millstone to pledge: for he taketh a man's life to pledge." Such millstones were used by the Roman legions in Britain, and are often found about their ancient camps and stations, but nowhere perhaps in such number and variety as in the county of Northumberland, along the line of the Roman wall, and many fine examples are preserved by the Anti-quarian Society of Newcastle-upon-Tyne.

These are generally about a foot in diameter, and made of the hard sandstone found in the coal districts, hence called millstone grit. The lower millstone was stationary; sometimes it was made larger than the upper stone, and had a rim or border to confine the meal and cause it to be delivered by a spout into a shallow vessel or sieve, but generally it was a round stone of the same size as the top stone, and must have been set on a cloth spread upon the ground to receive the meal.

An upright pin or pivot fixed in the centre of the nether millstone formed a kind of axis, and passed through a hole in the upper stone, which like the nether millstone was of a flat circular form. The upper stone was fitted with a handle to drive it round, and make it revolve over the lower stone; sometimes the upper surface of the top stone was hollowed into a shallow dish to hold a portion of the corn to be ground, which was gradually shaken down the hole round the fixed axis by the motion of the mill.

It is curious to observe that the principles on which corn-mills were constructed thousands of years ago, remain the same to the present day, and "the work" as millwrights call it, that is the system of grooves cut in the grinding faces of the millstones which crossing each other when in motion act like a pair of shears to cut the grain and also to throw it out from the centre to the circumference, are now

set out and formed in the same way as they were from the beginning. The sketch here given will perhaps afford a better explanation than many words.

Although the mill here described was a portable domestic implement, and some were even small enough to be held in the lap, yet it was often made of much larger dimensions, and was worked by many persons at once with levers or bars like a capstan, by men walking in a circle round it, and

Fig. 1.

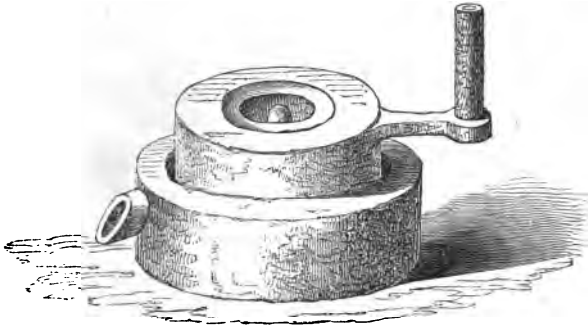

ORIGINAL MILL.

pushing the bars so as to turn the upper stone, while in some cases asses and other cattle were employed, and eventually the Romans used the power of water to drive their mills. A writer of the time thus eloquently alludes to this important improvement:

“Cease, ye maidens, ye who laboured in the mill; sleep now, and let the birds sing to the ruddy morning; for Ceres has commanded the water nymphs to perform your task. These, obedient to her call, throw themselves upon the wheel, force round the axletree, and, by these means, the heavy mill.”—*Beckmann's History of Inventions*.

The water-wheels first used to drive corn-mills were horizontal; they were of small size, and revolved rapidly. The axle passed through the centre of the lower millstone, as the spindle does now. It turned the upper millstone by means of a cross-bar fixed in the eye or centre of the stone, whilst a current of water directed against the vanes of the wheel on one side of the axle, urged it round. Such water-mills are still used in India; and a curious model of one, in its most simple and primitive form, was sent to the Great

Exhibition in Hyde Park. A modern traveller informs us that "all the flour-mills upon the River Meles at Smyrna are constructed in this way, and necessarily answer well in countries where water power is abundant: their great simplicity preventing their readily getting out of repair, while costing but little also." Some of these simple mills may yet be found in remote and mountainous parts of Italy and France.

Fig. 2.

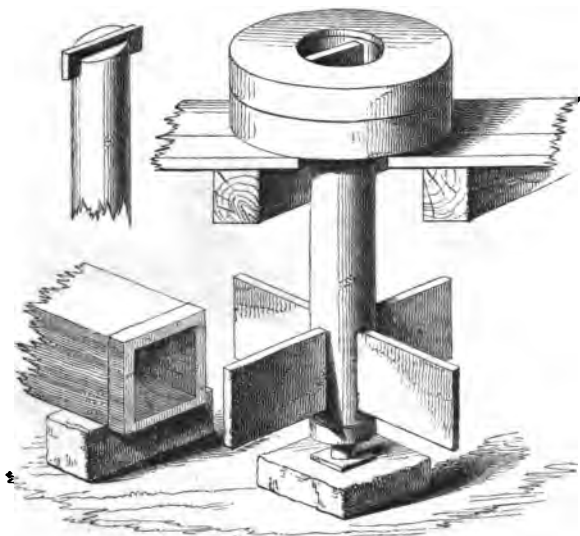

PRIMITIVE WATER-MILL.

The horizontal water-wheel is again coming into notice with many refinements and improvements of modern invention; and not far from the rude Indian model before mentioned might be seen the elaborate machine of Messrs. Fromont & Son, French engineers, made entirely of iron, capable of working to fifty horses' power, with a fall of two mètres, or six feet seven inches, and susceptible of such nice adjustment, as to be adapted to spin cotton and silk as well as to grind corn; while the inventor states, from his experience of similar wheels already in action, that he can obtain more than 70 per cent. of the power expended, and that, in one instance, the effective power has reached 79 per cent.

The Romans also used conical mills for grinding corn. A

very complete example of this kind was found in the excavations of Pompeii, where it had been buried for nearly seventeen centuries. The locality appeared to have been the shop of a wealthy baker; and the mill, which was of considerable size, was so fitted as to be worked by men or by cattle. It is remarkable that the conical flour-mill, in a modified form, should be again brought forward and exhibited as a modern invention, to which the proprietors attach the highest value. Two examples of conical flour-mills, both of them patented, appeared in the Great Exhibition of 1851, where, at the same time, was shown, in the East Indian section, a very neatly made conical mill, used in India for husking rice.

Fig. 3.

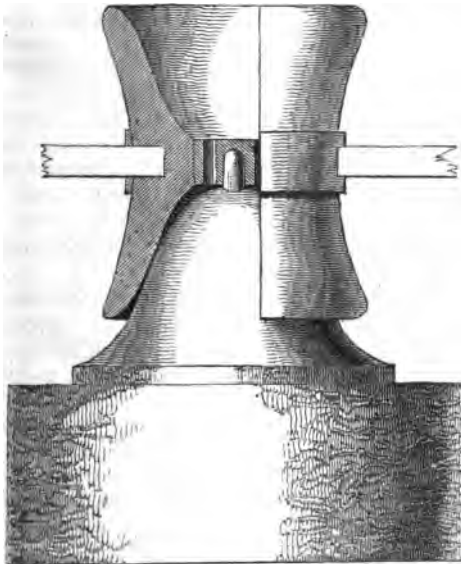

MILL FOUND AT POMPEII.

The vertical water-wheel appears to have been known to the ancients at a very early period, but it was chiefly used to raise water for the purposes of irrigation.

Examples of such wheels, in their original form and use, are still to be seen on the Nile and the Euphrates; and wheels are also employed by the Chinese to raise water for

their rice fields and cane plantations; those of Egypt and Syria generally resemble each other. The following description of them was given by Captain (now Colonel) Chesney, in his survey and report on the navigation of the Euphrates:—

“The scenery above the town of Hit, in itself very picturesque, is greatly heightened, as we are carried along the current, by the frequent recurrence, at very short intervals, of ancient irrigating aqueducts; which, owing to the windings of the river, appear in every variety of position, from the foreground of the picture to the distant part of the landscape. These beautiful specimens of art and durability literally cover both banks, and prove that the borders of the Euphrates were once thickly inhabited by a people far advanced, indeed, in the application of hydraulics to domestic purposes of the first and greatest utility, the transport of water.

“These speaking monuments of other times have, as may be supposed, suffered in various degrees during the lapse of so many ages of partial or entire neglect, and the greater portion is now, more or less, in ruins; but some have been repaired and kept up for use, either to grind corn or to irrigate, having a modern wheel attached to the ancient, simple, and most efficient model; the whole being, in some instances, sufficiently well preserved to show clearly the original application of the machinery.

“The aqueducts are of stone, firmly cemented, narrowing to about two feet or twenty inches at top, placed at right angles to the current, and carried various distances towards the interior from 200 to 1200 yards, their height being regulated by the level of the ground to be irrigated; the shorter distances have one height of arches, and the larger ones two, one above the other, both extremely pointed: in fact, almost forming a triangle from the spring of the arch to its point. At the one extremity of the structure, which is some little distance in the river, the building makes a turn *parallel* to the stream, and there widens sufficiently to contain one, two, or three, and, occasionally, four wheels, parallel to each other, and revolving with the current, each of about 33 feet diameter, and having a number of earthen vessels of three or four inches diameter, and 20 inches long, placed at about 18 inches apart, round the exterior rim of the wheel, which is formed of light small scantling, its greatest width being rather less than the diameter of the vessels attached to it; which, dipping a few inches into the

water, are filled and forced round by the current in succession, the open end foremost, until each, in turn, reaches the top, and there discharges its contents into a trough, which conveys the water from each wheel into the conduit of the aqueduct (an open one), with a gradual fall, as far as the place to be irrigated; and, as the wheels are moveable, so as to elevate the axles, by means of stones or beams of wood, as the water increases, they can work equally well at any height of the river; the earthen vessels giving of themselves a sufficient impetus, without any other means, except in some few places where the current happens to be weak, in which case, six or eight fans of palm branches, each about 18 inches square, are added to the sides of the wheel's circumference, to give the water more power upon it. Such additions are, however, very rare, and the earthen pots alone are almost always sufficient.

“But what most concerns the subject of this survey [the navigation of the Euphrates], is the existence of a parapet wall or stone rampart in the river, just above the several aqueducts; in general there is one of the former to each of the latter, and almost invariably between two mills on opposite banks, a wall crosses the stream from side to side, with the exception of a passage left on the centre for boats to pass up and down. The object of these sub-aqueous walls (mistaken by Alexander the Great for means of defence against his irresistible legions) would appear to be entirely with a view to raise the water sufficiently at low seasons, to give it impetus, as well as a more abundant supply to the wheels; and their effect at times is to create a fall in every part of the width, save the opening left for commerce, through which the water rushes with a moderately irregular surface: these dams were probably from four to eight feet high originally; and they are now frequently a bank of stones, disturbing the evenness of the current, but always affording a sufficient passage for large boats at low seasons: and ceasing to be very perceptible, except by the broken surface, after the water is swollen.

“Ten miles below the town of Hit, the last of these irrigating mills and artificial barriers is passed, and a few miles lower the double range of hills is nearly lost, and the country becomes comparatively flat.”

The water-wheel used in China unites with the simplicity of all Chinese mechanism great ingenuity of construction and adaptation. The change of position of the buckets, if

they may be so called, produced by the revolution of the wheel, without any motion of the buckets themselves, well deserves to be noticed.

Two hard wood posts or uprights are firmly fixed in the bed of the river, in a line perpendicular to its banks; these posts support the pivots of an axis of about ten feet long: this is the axis of a large wheel, consisting of two rims of unequal diameter, the rim which is nearest to the river's bank being fifteen inches less than the other; but both rims dip into the stream, and both rise above the trough or spout which receives the water and conveys it to the land to be irrigated.

The only materials employed in the construction of this water-wheel, except the axle and the two posts on which it rests, are afforded by the bamboo. The rims, the spokes, the ladle-boards or floats, the tubes or buckets, are made of entire lengths, or large pieces, or thin slices, or single joints, of bamboo; neither nails, pins, nor screws, nor any kind of metal, are used; the parts are firmly bound together by cordage of split bamboo or cane.

The wheel is thus framed,—sixteen or eighteen spokes are inserted obliquely into the axis near each extremity, and cross each other at about two-thirds of their length; the wheel is strengthened where the arms cross, by a concentric circle, and the ends of the arms or spokes are secured to the two rims. The spokes proceeding from the inner end of the axis next to the river's bank support the larger or outer rim, and those from the outer or inner end of the axis support the smaller rim, which is next to the land.

Between the rims and the crossing of the spokes is a triangular space, which is woven with a kind of close basket-work to serve as ladle-boards or floats; these, successively entering the stream, are impelled by the current, and turn round the wheel.

The buckets are tubes of bamboo, closed at one end and attached to the two rims of the wheel, and so fixed that when they are on a level with the axle, they have an inclination of twenty-five degrees to the horizon and to the wheel's axis.

The closed end of the tube is of course the lowest, and it is fastened to the outer and larger rim; the open end is attached to the smaller rim nearest the land. By this position, the buckets which dip into the stream as the wheel revolves, fill with water and rise with their mouths uppermost; their inclination gradually alters as they rise, but not

so much as to let their contents flow out until they reach the top, when they pour the water into a wide trough, from which it is distributed to the plantations.

These wheels are from twenty to forty feet in diameter, according to the height of the land on the river's bank and the consequent elevation to which the water must be raised.

Fig. 4.

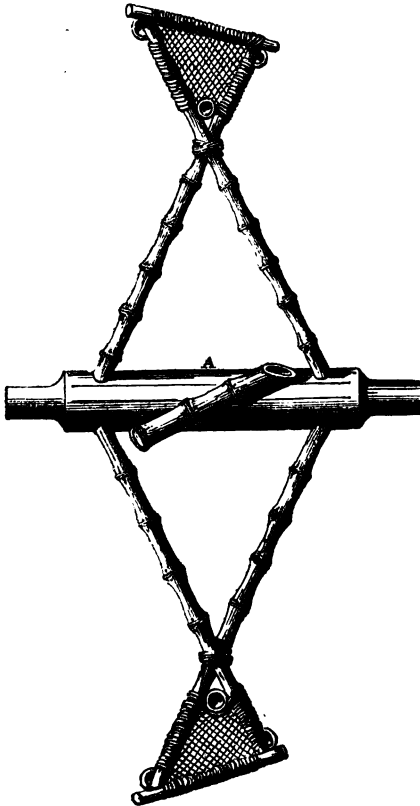

CHINESE WHEEL.

A wheel of thirty feet carries twenty tubes or buckets, about four feet long and two inches inside diameter, each of them holding six-tenths of a gallon, or twelve gallons in the whole. With a stream of moderate velocity, the wheel will

make four revolutions in a minute and lift forty-eight gallons of water, or 2,880 gallons in an hour, or more than 69,000 gallons per day.

The position of the bucket as it rises to the level of the axle is shown at A. See figure.

Thus, at a very trifling expense, a machine may be constructed, which, without labour or attendance, will furnish a large and constant supply of water for agricultural purposes at a considerable elevation. There are many places in England where such means of irrigation might be used with advantage.

CHAPTER II.

THE NATURE AND PROPERTIES OF WATER.

HAVING thus briefly noticed the early use of water as a motive power, it may perhaps be well, before proceeding farther, to consider the nature and properties of water itself, so far as concerns the present treatise.

It was long held to be one of the four elements, and a hundred years have not yet passed away since it was proved that water is not a simple substance, but that it is composed of oxygen and hydrogen. The honour of announcing this fact appears to belong to James Watt; the researches of Dr. Black, and the experiments of Mr. Warltire, Mr. Cavendish, and Dr. Priestley, led him to this conclusion, which is stated in a letter dated April 26th, 1783, addressed by Mr. Watt to Dr. Priestley, through whom it was communicated to the Royal Society, who printed it in their Transactions.

The idea of the four elements must now be treated only as a beautiful allegory, a subject on which sculptors and artists may exercise their imagination and their skill.

According to Dr. Dalton, water consists of 8 parts by weight of oxygen and 1 of hydrogen in 9 of water. It exists in four states: as a solid in the form of ice, liquid as water, in the state of vapour as steam, and it exists also in combination with other bodies. Although it is, strictly speaking, in the liquid form alone that we have now to consider it, yet it may be noticed, as important to the

present subject, that water expands in bulk and decreases in density from a temperature of 39 degrees of Fahrenheit's thermometer up to 212, when it boils and evaporates into steam; that below 39 degrees it again expands and decreases in density down to 32 degrees, when it crystallises into ice.

It is seldom that this difference of density and volume is of much consequence in mechanical practice, yet it is most important as it respects the great operations of nature; the expansion of water in assuming the form of ice should never be forgotten by those who have to construct hydraulic works; its bulk is then increased in the proportion of 9 to 8, and the force with which it expands is so great that scarcely anything will resist it. The strongest pipes and vessels of iron are split, the heaviest weights are lifted, masonry and even rocks are rent asunder, when water having found its way through some small chink or opening, has frozen within the mass; and experiments have rendered it probable that a single cubic inch of water confined and frozen, exerts within the range of expansion a force equal to 13½ tons. It is therefore absolutely necessary that care be taken either to prevent water from lodging or to provide means for allowing it to expand when it freezes.

By thus becoming lighter than water, ice floats upon the surface, and by exposure to the sun's rays is quickly melted; besides the warmest water also comes to the top and assists in melting the ice.

The earth, however, is a good non-conductor of heat, and in the temperate climate of England, the frost seldom reaches more than 10 or 12 inches below the surface of the ground in the coldest winter, so that water-pipes laid at the usual depth of two feet underground are sufficiently protected from freezing. The combination of water with other bodies, although a chemical operation, is most valuable to those whose business it is to build dams and sluices. If water be thrown on quick lime, nothing but a red heat will again separate them; plaster of Paris in the state of powder becomes solid when mixed with water. Barrow lime and other limes of similar character from the lias beds, and Roman cement, become solid and remain hard under water.

A cubic foot of rain-water at a mean temperature, when the barometer stands at 29.5 inches, weighs 1000 ounces avoirdupois, or 62½ lb.; consequently water is generally taken as the standard point in tables of specific gravity, in

which the weight of equal bulks of other substances are compared with that of water in ounces to the cubic foot.

A cubic foot contains 1728 cubic inches, and the imperial standard gallon 277·274 inches; a pound avoirdupois weight of water contains 27·64 cubic inches; so that an imperial gallon may be taken to weigh 10 lb., and a cubic foot to contain $6\frac{1}{4}$ gallons.

A pipe of one inch in diameter, and one yard in length, contains 28·26 cubic inches, or a pound of water very nearly. Hence the following practical rule is generally used by millwrights to find the quantity of water in a pipe of any given diameter:

Square the diameter of the pipe in inches, and you have the weight of water in pounds per yard of the pipe's length; shift the decimal point one place to the left and you have the quantity of water per yard in gallons.

Thus if a pipe be 12 inches in diameter, 144 will express the weight of water it contains in pounds per yard long, and 14·4 the quantity in gallons, with sufficient exactness for any practical purpose in mill-work.

The force required to compress water, even to render the diminution of its bulk appreciable, is so great, that practically it may be regarded as incompressible, and consequently non-elastic. Hence it is that when a strong iron vessel, as the cylinder of a hydraulic press, is burst by overloading it, no explosion takes place; the breaking of the metal at once relieves it from a force so limited in its range of expansion, that the fragments do not fly asunder, but fall as if broken by mere weight.

The author witnessed the compressure of water by the apparatus of Mr. Perkins; and Professors Colladon and Sturm, in a series of experiments carefully made on water completely deprived of air, reduced its bulk $\frac{1}{810}$ with a pressure of 24 atmospheres.

This resistance to compression renders water so useful a medium for transmitting and multiplying power by means of Bramah's press, and thus by the hydraulic ram, the impulse of a fall of water a few feet in height through an enclosed pipe, when suddenly checked, strikes as it were a blow which will force a portion of the stream much higher than the level of the dam from which it flows.

Water in falling is subject to the same laws of gravitation as other heavy bodies, but in the operation of those laws there is this difference; namely, that a detached body, as a

stone, a mass of metal, a cannon-ball for instance, falls freely and without other retardation or resistance than that of the air, or without any retardation, if it fall *in vacuo*; but water to fall must flow also, consequently in speaking of the fall of water we mean a continuous stream, or jet or sheet of water descending from a higher to a lower level, all parts of which are in motion at the same time, and in constant connection with the succeeding column and adjacent body of water, to which also motion is communicated, and consequently force is lost.

If a ball of lead be dropped from a high tower, it falls (as nearly as may be) 16 feet 1 inch in one second of time; at the end of that time it has acquired a velocity of 32 feet 2 inches; it falls in the next second, 48 feet 3 inches, and in two seconds of time it has fallen 64 feet 4 inches. So that if the time or seconds be represented thus, the time 1" 2" 3" 4" 5"; the spaces fallen in each second will be as 1, 3, 5, 7, 9; the spaces fallen through in the whole time as 1, 4, 9, 16, 25. This proportion holds good for any time or space through which a body falls *in vacuo*; but the air's resistance in the present case does not materially interfere, and may be disregarded within the limits of a fall of water applied to mechanical purposes.

Thus the velocities are as the times of descent, and the spaces fallen through are as the squares of the times; consequently, the velocities are as the square roots of the heights or spaces through which a heavy body falls; therefore, as gravitation produces the velocity of 2 in descending through the space 1, the height in feet through which the body falls, being multiplied by 64·3, will give the square of its velocity, in feet, per second. So if the height fallen be 1 foot, the square root of 64·3, or 8·02 (very nearly), is the velocity with which a heavy body falls through that space.

The difference between a flowing and a falling body is evident, although both are governed by the laws of gravitation, and accordingly we find that the motion of fluids has attracted the attention of mathematicians and philosophers, from a very early period, in Italy, France, Germany, and England, up to the present day; and many experiments have been made from time to time, to ascertain exactly the value of this difference. The late Mr. Rennie, being much engaged in the improvement of rivers, the drainage of large tracts of land, and the application of water to turn mills, made many elaborate experiments for this purpose; his

researches have been ably continued by his sons, and Mr. George Rennie has contributed to the Transactions of the Royal Society some valuable papers on the subject: subsequently, an extensive series of experiments was made by MM. Poncelet and Lesbros, by order of the French government.

The value and importance of such investigations will be apparent, when it is considered that the first points to be determined, in all great hydraulic works, are the quantity of water available for the object in view, and the height from which it falls.

These constitute the power to be employed; and when these are known, the application of the disposable force to produce the greatest effect is next to be considered.

The quantity which a stream will yield in a given time, is generally ascertained by placing a dam or barrier across it, commonly of timber. In this there is either a sliding sluice, through which the water is discharged, so that the size of the rectangular orifice can be regulated at pleasure; or else a rectangular notch is cut in the edge of the dam, at the surface of the water, so that the section of the passing stream may be measured as it flows through the notch.

If the water flow through an opening in the dam, so adjusted by a sluice that the discharge runs constantly through it, while the dam is maintained either full or at an uniform level above the opening; and if the laws of gravitation, without allowance or correction, governed the flow, it would only be requisite to measure the area of the opening, and to calculate the velocity of the water as that of a heavy body falling from the surface of the dam or reservoir through the centre of the orifice, and the area multiplied by the velocity would give the quantity of water passing through it.

In like manner, if no correction were required, to find the quantity of water flowing through a rectangular notch, cut in the upper plank of the barrier, it would only be requisite to measure the height from the surface of the reservoir to the bottom of the notch, in order to find the velocity as before; and then to take two-thirds of the quantity which would flow at that velocity through the whole area of the notch, the proportion of two to three, that is the area of the parabola described by the water, being two-thirds of its circumscribing rectangle.

Such, indeed, were the rules given by some of the best

authorities; but the evidence of the senses cast a doubt on their truth, and experiments showed that the actual quantity of effluent water was less than the theoretic quantity.

Sir Isaac Newton found that the velocity of water issuing from a round hole in the bottom of a vessel four feet high, the hole being an inch in diameter, and made through a thin plate of metal, was less than it ought to be in the proportion of 1 to the square root of 2; for he observed the vein of the effluent water, and found it to contract, and grow narrower, to the distance of about a diameter of the hole below the bottom of the vessel, so that the diameter of the vein at this place was less than the diameter of the hole, in the proportion of 21 to 25, and consequently, the area of the section of the vein thus contracted, to be less than the area of the hole, in the proportion of 441 to 625; that is, as 1 to the square root of 2, or as .7056 to 1.

But as all experiments of this kind, made by mathematicians, were of necessity conducted on a small scale, the results deduced from them were by no means satisfactory to men who had to deal with water in the execution of large works, as it was not probable that the causes of contraction in a vein of water an inch in diameter, would bear the same proportion to the waters of a river discharged through a sluice.

Hence it was, that persons in extensive practice endeavoured to form rules for themselves, based on their own experience; and as the circumstances in which such observations were made varied, so did the rules deduced from them vary also. Mr. Rennie made many experiments and observations to determine the difference between the theoretic discharge (computed by the laws of gravitation) and the actual discharge diminished by friction, lateral retardation, reaction of the adjacent fluid, and other causes of diminished velocity or volume and consequent quantity. Other engineers did the same. The French government, considering the question as one of public interest, appointed a commission to determine it: the elaborate experiments on the great scale, made by their engineers, under the direction of MM. Poncelet and Lesbros, brought it within narrow limits; and, in December, 1851, the Institution of Civil Engineers, in London, awarded an honorary premium to Mr. Blackwell, one of their members, for his paper, entitled "Results of a series of practical experiments on the discharge of water by over-falls."

CHAPTER III.

ON THE MEASUREMENT OF EFFLUENT WATER.

THERE is perhaps no point which has occasioned more dispute and litigation, than the conflicting rights of persons entitled to take water power, in certain proportions, from a common source, where the demand exceeds the supply; and there are perhaps few of greater interest at the present time, when the increased size and population of our towns and cities render their call for water imperative.

The conclusions arrived at by Mr. George Rennie, as reported in the Philosophical Transactions of the Royal Society, are,—

1. That the quantities discharged in equal times are as the areas of the orifices.

2. That the quantities discharged in equal times, under different heights, are *nearly* as the square roots of the corresponding heights.

3. That the quantities discharged in equal times, under different heights, are to each other in the compound ratio of the areas of the apertures, and of the square roots of the heights, *nearly*. The heights were measured from the centre of the apertures; and the mean of several experiments showed, that the co-efficients or numbers expressing the proportion between the theoretic discharge of the water, calculated as a falling body, and the actual discharge, as measured, are as under; all the openings being formed in brass plates $\frac{1}{8}$ of an inch thick.

Round hole, 1 inch diameter, with 4 ft. head.	0·621
Do. do. 1 ft. "	0·645
Triangular hole (equilateral) 1 in. area 4 ft. "	0·593
Do. do. do. 1 ft. "	0·596
Rectangular holes 1 in. sq. and $2 \times \frac{1}{2}$ 4 ft. "	0·593
Do. do. do. do. 1 ft. "	0·616

The mean of all these numbers is '610, and for the rectangular holes, it is '600. Hence Mr. Rennie deduces the following formula:—

Let A = the area of the orifice in square feet.

H = the altitude or head of water in feet.

T = the time in seconds.

g = the action of gravity in one second.

Q = the quantity of water discharged in cubic feet.

Suppose the hole to be 2 feet long and 6 inches wide, the area 1 square foot, having the long side parallel with the water's surface, and a head of 4 feet above the centre of the hole. Then will $Q = .6 A T \sqrt{g H}$.

Thus—multiply 64.3, the effect of gravity, by 4 feet, the head of water, for the theoretic velocity in feet per second; and as the area is 1 square foot, the velocity will also be the quantity discharged per second in cubic feet.

$$\begin{array}{r}
 64.3 \\
 \quad 4 \\
 \hline
 1 \overline{) 257.2} \quad (16.037 \\
 \underline{1 \quad 1} \\
 26 \overline{) 157} \\
 \underline{6 \overline{) 156}} \\
 3203 \overline{) 12000} \\
 \underline{3 \quad 9609} \\
 32067 \overline{) 239300} \\
 \underline{\quad \quad 224469}
 \end{array}$$

$$\begin{array}{r}
 16.037 \\
 \quad .6 \\
 \hline
 \end{array}$$

Actual discharge 9.6222 cubic feet per second.

or, 577.332 cubic feet per minute.

The results of the experiments made by MM. Poncelet and Lesbros by order of the French government, in which neither labour nor expense was spared, show that with an opening of 20 centimètres or 7.87 inches square, and with a head of 1 mètre 68 centimètres or 5 feet 6 inches from the upper side of the opening to the surface of still water, the co-efficient is 0.600. When the head or altitude was diminished to four or five times the height of the opening it increased to 0.605, but it again diminished rapidly, as the altitude diminished to 0.593.

With orifices of smaller dimensions; namely, from 10 to 5 centimètres (3.9371 to 1.9685 inches) the same law was

observed, the co-efficients being for an opening of 10 centimètres 0·611, 0·618 and 0·611; for an opening of 5 centimètres 0·618, 0·631 and 0·623.

It is evident that with small orifices the effect of high heads would be to contract the vein and diminish the discharge, and the nearer the orifice could be brought to the surface, so that it might still be kept running with a full stream and without causing any depression of surface or eddy, the greater would be the discharge. But with larger apertures, of a mètre in length, by 50 centimètres in depth, or $39\cdot371 \times 19\cdot685$ inches, equal to 5·38 square feet in area, the co-efficients gradually increased with an increased head or altitude, thus:—

A head of 0·10 mètres =	3·937 inches,	gave a co-efficient of	0·552
” 1·00 ”	39·371 ”	”	0·591
” 4·00 ”	157·484, or 13 ft. 1½ in.	”	0·604

All these observations and experiments differ so little, that ·6 of the theoretic quantity may be taken for general practice.

The proportion between the theoretic and the actual discharge from open notches in dams, was found to be ·677 when the notch was 9 inches deep, and ·727 when it was 1 inch deep; and, as the discharge from an open notch is equal to $\frac{2}{3}$ of that from an orifice of the same size discharging a full stream under the same head, these numbers being multiplied by ·666, give ·450, and ·484 as the factors for finding the quantities of water issuing from notches of those depths in a second of time—for greater depths, and as a general rule, ·400 may be used. Mr. N. Beardmore, in his useful handbook of tables, showing the discharge through sluices, pipes, &c., finds his calculations of the flow of water through open notches on the following formula—

$$D = 214 \sqrt[3]{H^2}$$

taking D to be the quantity discharged in cubic feet per minute over 1 foot in width of the waste board or sill of the notch, and H to be the true height from the sill of the notch to the surface of the water where it is at rest. The principle of this formula, as in those already noticed, is, that the curve of the water falling over being a parabola, there can be discharged only two-thirds of the water that would pass the full section due to H ; the constant number 214 is two-thirds of 321, which he states has been found by frequent trials to represent the factor to be multiplied by the square

root of H , the height in feet for giving the mean velocity in feet per minute of water passing over a waste board.

Assuming this to be correct, the velocity, and consequently the quantity of water which would run over every foot in width of a rectangular notch, 1 foot in depth from the water's surface, would be 214 cubic feet per minute.

The square root of 64.3, or 8.02, which is the theoretic velocity for 1 foot fall, multiplied by 0.45, gives for the actual velocity, 3.601 in feet per second, and this by 60 gives 216 cubic feet per minute.

Fig. 5.

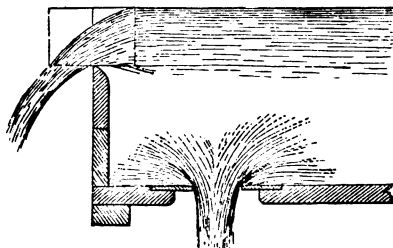

This difference is very small compared to what may arise from the form of the notch or aperture; for a plain rectangular notch with square edges cut in a 3-inch plank, will discharge very much less than one having its inner edges next the reservoir, or dam whence the stream issues, bevelled off in the parabolic form of the contracted vein. If the notch or aperture be of small dimensions, a difference of one fourth of the whole quantity may be made, as was proved by Venturi, and in works on a larger scale; care should be taken to form the wing walls to sluices, and bridges, with parabolic or "trumpet-shaped" approaches, so that the water may enter and pass without other obstruction than the contraction of the overflow, or sluice-way itself may present to it; and when water passes through a parallel channel, canal, or trunk, the sectional area, multiplied by the mean velocity, will show the quantity passing in a given time.

The mean velocity is that of the water's surface added to that at the bottom of the current, and their sum divided by two, or it may be determined sufficiently near for any useful purpose, by ascertaining the surface velocity in inches per second in the middle of the stream; call this velocity s , and

the mean velocity will be equal to $s - \sqrt{s - 5}$. Suppose the stream flows at the rate of 36 inches per second, or 180 feet per minute upon the surface, then

<p>s being equal to 36 inches</p> <p style="padding-left: 40px;">deduct 5</p> <p>extract the square root } $\begin{array}{r} 5\overline{)31\cdot(5\cdot5} \\ 5\overline{)25} \\ \hline 105\overline{)600} \\ 525 \end{array}$</p>	<p>36</p> <p>5·5</p> <p>$\overline{30\cdot5}$ in. per second.</p> <p>60</p> <p>$\overline{12\overline{)1830\cdot0}}$</p> <p>$\overline{152\cdot5}$ ft. per minute.</p>
---	---

If 30·5 the mean velocity in inches per second be multiplied by 5, the product is 152·5, the mean velocity in feet per minute. The bottom velocity will be equal to $s - \sqrt{s + 5}$ or $36 - 11 = 25$ inches per second, or 125 feet per minute, very nearly; the sum of the top and bottom velocities so calculated is 305, and half that sum is 152·5. If, therefore, the water-course be 4 feet wide and 2 feet deep, having a sectional area of 8 feet, $152\cdot5 \times 8$ or 1220 cubic feet will pass through it in one minute.

While writing these pages the author received a copy of Mr. Blackwell's paper containing the details and results of his numerous and varied experiments.

Mr. Mylne, of the New River, kindly sent a series of experiments, in making which he was assisted by Mr. Murray, then his pupil; and other engineers, engaged in water-works on a large scale, contributed their observations, and the practical rules they had founded upon them.

In principle all these rules agree; their corrections vary less than might be expected; and their expression is generally similar to the formula given by Mr. George Rennie, in his paper, read to the Royal Society, which Mr. Blackwell has called No. 1, and writes thus:—

$$Q = \sqrt{2g} H \times l H \times m.$$

in which

Q is the discharge in cubic feet per second.

$2g = 64\cdot3$ the effect of gravity (Mr. Rennie's g).

H the head in feet ($l H$ the section of the stream).

l width of the overfall in feet.

m the co-efficient of correction.

Or they resemble the following formula, which he calls No. 2, and writes thus:—

$$Q = H^{\frac{3}{2}} \times l \times k.$$

in which

Q is the discharge in cubic feet per second.

l the width of overfall in feet.

H the head in inches.

k the co-efficient of correction.

The head is the height of still water above the sill of the overfall.

Mr. Mylne's rule runs thus:—Extract the square root of *two-thirds* of the head or depth, measured in inches, from the sill of the overfall to the surface of the still water, and multiply it by sixteen for the velocity in inches per second; multiply this velocity by the section of the stream, also in inches, and divide the product by 1728, the number of inches in a cubic foot, for the quantity in cubic feet discharged per second. A practical allowance for retardation is here made, by taking two-thirds of the head instead of the whole.

With respect to the formulæ, No. 1 and No. 2, which are in general use, the only difference among engineers is in the numbers they take as co-efficients of correction. The number commonly taken by English engineers is 5.1 or 5.15 per foot per minute.

Thus, if the depth of overfall be 12 inches, the cube is 1728, and the square root of this, 41.58×5.15 , gives the discharge through an open notch a foot square, as 214.1876 cubic feet per minute, the same as shown in Mr. Beardmore's tables.

Mr. Mylne's rule gives 226.2 cubic feet. Some engineers use 5.35 and 5.4, which last number gives 224.532 cubic feet per minute. Mr. Blackwell's experiment, like those of the French engineers, MM. Poncelet and Lesbros, show that the co-efficients vary with the depth, the width, and the form of the notch or overfall, and that all the numbers used are, strictly speaking, applicable only to the peculiar circumstances of each particular case, although, within certain limits, they may approximate sufficiently near to the truth for practical purposes.

These experiments, 243 in number, were made by Mr. Blackwell on the Kennet and Avon Canal, through overfalls varying in width and form.

1. With the water falling over the edge of a thin iron plate, through notches 3 feet and 10 feet long, of varying depths.

2. Over a plank, 2 inches thick, through notches, 3 feet, 6 feet, and 10 feet long.

3. Over the same plank, 2 inches thick, with wings converging towards the notch at an angle of 64 degrees.

4. The notch, 3 feet wide, with the sill or crest, 3 feet broad, sloping 1 in 12, fixed on to the outer edge of the plank, so as to form an uninterrupted continuation of it, like the crest of a weir.

5. The same, with the crest or sill sloping 1 in 18.

6. The overfall, with notch 10 feet long, the crest or sill 3 feet broad, laid level.

Similar experiments (about twenty in number) were made at Chew Magna, under the direction of Mr. James Simpson, which are tabulated in Mr. Blackwell's paper with his own; and this table gives perhaps the best arranged view of the subject which has yet appeared. The reader who desires to know the details of these experiments is referred to Mr. Blackwell's communication of May 6, 1851, in the Proceedings of the Institution of Civil Engineers—a paper which well deserves perusal and study.

TABLE showing the VARIATION of the CO-EFFICIENTS for the different OVERFALLS. (*m* and *k* mean Co-efficients.)

Overfalls.		<i>m</i>	<i>k</i>
Thin plate,	3 feet long . . .	·421	·080
	10 " . . .	·445	·086
Plank, 2 inches wide,	3 " . . .	·380	·073
" "	6 " . . .	·377	·072
" "	10 " . . .	·371	·072
" (with wings)	10 " . . .	·459	·090
Bar, 2 inches wide, Chew Magna,	10 " . . .	·480	...
Crest, 3 feet wide, sloped 1 in 12	3 " . . .	·338	·065
" "	1 " 18 3 " . . .	·339	·065
" "	10 " . . .	·337	·065
" "	level 3 " . . .	·311	·060
" "	" 6 " . . .	·322	·061
" "	" 10 " . . .	·314	·061

It will be observed that the means of these numbers for simple overfalls or notches, excluding those given by the broad crests, made to resemble the top of a stone weir or dam, are for *m* ·419, and for *k* ·079; which last number being multiplied by 60, to make it the factor for feet per

minute, gives 4.74. So that the first is slightly over Mr. George Rennie's .400, and the second somewhat under the number 5.1 or 5.15 generally used. This is accounted for by so many experiments with low heads, as will be seen on referring to the next table, arranged by Mr. Blackwell.

TABLE showing the VARIATION of the CO-EFFICIENTS for the different HEADS OF WATER. (*m* and *k* mean Co-efficients.)

No. of trials.	Description of Overfalls.	Head in inches.	<i>m</i>	<i>k</i>		
6	Thin plate 3 feet long	1 to 3	.440	.085		
		3 to 6	.402	.078		
11	Thin plate 10 feet long	1 to 3	.501	.096		
		3 to 6	.435	.086		
		6 to 9	.370	.072		
23	Plank 2 inches thick, with notch 3 feet long	1 to 3	.342	.066		
		3 to 6	.384	.074		
		6 to 10	.406	.077		
56	Plank 2 inches thick, with notch 6 feet long	1 to 3	.359	.069		
		3 to 6	.396	.077		
		6 to 9	.392	.074		
	" " "	9 to 14	.358	.069		
		40	Plank 2 inches thick, with notch 10 feet long	1 to 3	.346	.068
				3 to 6	.397	.076
6 to 7	.374			.072		
	" " "	9 to 12	.336	.062		
		4	Plank 2 inches thick, notch 10 feet, with wings	1 to 2	.476	.092
4 to 5	.442			.087		
7	Overfall with crest	1 to 3	.342	.066		
		3 to 6	.328	.063		
		3 to 6	.311	.060		
	3 feet wide, sloping 1 in 12	6 to 9	.311	.060		
		9	Overfall with crest	1 to 3	.362	.070
				3 to 6	.345	.066
3 to 6	.332			.064		
	3 feet wide, sloping 1 in 18	6 to 9	.332	.064		
		6	Ditto. Sloping 1 in 18	1 to 4	.328	.063
3 to 6	.350			.068		
	3 feet wide x 10 feet long	4 to 8	.350	.068		
		14	Overfall, with level crest	1 to 3	.305	.059
				3 to 6	.311	.060
3 to 6	.311			.060		
	" " "	6 to 9	.318	.061		
		6 to 9	.318	.061		

No. of trials.	Description of Overfalls.	Head in inches.	m	k
15	Overfall 6 feet long, with level crest 3 feet broad.	3 to 7	·330	·062
		7 to 12	·310	·060
12	Overfall with level crest, 10 feet long, 3 feet broad	1 to 5	·306	·059
		5 to 8	·327	·063
		8 to 10	·313	·061
61	At Chew Magna, overfall bar, 10 feet long, 2 inches thick . . .	1 to 3	·437	
		3 to 6	·499	
		6 to 9	·505	

It appears from the detailed experiments, that when the overfall is a thin plate it discharges a greater proportionate quantity when the stream is only 1 inch deep than with greater depths, the vein contracting with the increased head, and consequent force of the stream. When planks 2 inches thick form the overfall, the flow of water being more retarded, a greater head is requisite to overcome the resistance; and the maximum discharge is given by a head of 7 inches; and it does not afterwards increase in proportion to the depth, but the co-efficient lessens as the depth becomes greater. When the length of the overflow plank is 10 feet, the co-efficient is greatest with a depth of 5 inches, namely .406; and when wing-boards are added, causing the stream to converge towards the overfall, at an angle of 64°, the co-efficient is greater even when the head is less, and shows the great utility of proper wing-walls on bridges and sluices. When the overfall has a broad crest like a weir, the co-efficient, as might be expected, decreases, and is least when the crest is level.

The author has been anxious to avail himself of the many observations and experiments with which he has been favoured on this part of his subject, respecting which so much difference of opinion has existed, and to bring the whole, which were scattered in different places, and in several hands, into one general view, even at the risk of being somewhat tedious to his readers. The public is much indebted to Mr. Blackwell for having laid these numerous trials before the Institution of Civil Engineers, to be printed in their Proceedings; and it ought to be more generally known that such valuable papers are not merely given to

members, but they may be purchased from the booksellers' by all who wish to possess the store of practical information they contain.

CHAPTER IV.

THE SOURCES AND SUPPLY OF WATER ITS DISTRIBUTION AND USE AS A MOTIVE POWER.

THE westerly winds which prevail in this country carry with them the clouds, laden with aqueous vapours, rising from the Atlantic Ocean; and, as these clouds strike the ridges of hills on the western side of England, they discharge the greater part of their burden there.

The greatest fall of rain takes place where the lowering rain cloud comes in contact with the hill. Above that point little rain falls, and below it the quantity is diminished until the vapours approach the general level of the ground, when they condense, and the quantity of rain again increases. The observations, made on lofty buildings, show that less rain falls on them than on the ground at their base, and that the quantity of rain falling on the east side of the island is much less than on the west side.

In the west of Scotland, and in some places in the counties of Cumberland, Westmoreland, and Lancaster, a depth of six feet of rain often falls in the course of the year, while, on the level lands of Cambridgeshire, on the eastern side of England, the depth seldom exceeds two feet. The same causes operate on the continent; the western coast receives the greatest amount of rain, and it lessens towards the interior; so that Russia and Austria are dry climates, when compared with Great Britain and Ireland. The average annual amount of rain at St. Petersburg, including also the snow and hail (when melted), is only 18 inches in depth, during a long series of years.

Mr. J. F. Miller, in his report on the fall of rain in the lake districts of Cumberland and Westmoreland, shows that at Seathwaite, near Derwentwater, 242 feet above the sea, there fell in eighteen months, from June 1846, to November 1847, inclusive, 193·69 inches in depth; and, in the same period, at Styhead, 1290 feet above the sea, 164·12 inches;

at Seatoller, 1334 feet high, 155·75 inches; and at Sparkling Tarn, 1906 feet high, 183·17 inches.

These differences appear to have arisen from local circumstances, and the peculiar formation of the hills, as the inference he draws from a series of experiments and observations, is that, in the locality where they were made, the level of the heavily charged rain cloud would be about 2000 feet above the sea, and the greatest fall of rain be at that point.

The average quantity of rain falling in England over the whole surface of the country may be taken at about three feet in depth; and the quantity carried off by evaporation, absorption, and vegetation, has been found to amount to about two-thirds of the whole rain, snow, and hail, coming from the clouds.

In Ireland the case is nearly the same; for, although the air is moist with mists and dew, which constantly renew and refresh the verdure of the "Green Island," there is but little difference in the average quantity of rain. Sir Robert Kane, who has carefully investigated this subject, shows that it may be taken at 36 inches, and assumes that 12 inches of water finally arrive at the sea; which water may, in its course, become available for the purposes of industry, with a force proportionate to the height through which it falls as it flows onward.

It is written by the wisest of men, "All the rivers run into the sea, yet the sea is not full; unto the place from whence the rivers come thither they return again."

Providence has furnished mechanical power; it is for man to make it available. The sister kingdom is abundantly supplied with the means; and, although some persons may not estimate the amount of water power so highly as Sir Robert Kane, yet he clearly shows that an enormous quantity is constantly running to waste; and his map, which exhibits, at one view, the principal streams, and the elevation of the land in Ireland, renders it evident how much may be done by applying this to useful purposes. He thus sums up his calculations:—

"The average elevation of the surface of the country being 387 feet, the water which flows in our rivers to the sea has an average fall of 129 yards; and now, finally, we may calculate the total water power of Ireland. We have for the total quantity of rain falling in a year 100,712,031,640 cubic yards; of this one-third flows into the sea; that is,

83,237,343,880 cubic yards; or for each day of twenty-four hours, 91,061,216 cubic yards, weighing 68,467,100 tons.

“This weight falls from 120 yards; and as 884 tons, falling 24 feet in twenty-four hours, is a horse power, the final result is, that in average we possess, distributed over the surface of Ireland, a water power capable of acting night and day, without interruption, from the beginning to the end of the year, and estimated at the force of 3227 horses’ power per foot of fall; or, for the entire average fall of 387 feet, amounting to 1,248,849 horses’ power.”

Of course, much of this enormous force exists where circumstances prevent its becoming useful; and much passes away in navigable rivers, where it cannot be applied with advantage; but there still remains an immense amount of mechanical power, available for the purposes of industry, and at present unemployed.

Sir Robert calculates the water power of the principal rivers and their tributaries in a very clear and interesting manner. But it is not from the rivers alone that the great mechanical power of water is to be derived. Modern practice has shown that, by throwing up an embankment across a mountain pass, or in the gorge of a valley, which expands itself among the hills, large reservoirs—or rather artificial lakes—may be formed, to receive the water which rolls down the declivities from the bursting rain cloud, and to store it up for future benefit.

Two of the greatest works of this kind are, the embankment of Lough Island Reavy, in Ireland, by Mr. Fairbairn, and the Shaw’s Water-works at Greenock, in Scotland, by Mr. Thom.

The mill-owners on the Upper Bann were subject to great disadvantages. They were flooded in winter, and in summer the drought stopped their works. In order to economise the winter floods, which were destructive rather than useful, they consulted Mr. Fairbairn, and he thus reported:—

“Lough Island Reavy, which is the best situated reservoir, is a natural lake, bounded north and south by land of considerable elevation. It has good feeders, which, with the overplus waters of the River Maddock, would give ample supplies, and fill the reservoir once or twice in the year. The present area of the Lough is 92½ statute acres. On this is to be raised 35 feet of water, which may be drawn down to a depth of 40 feet under that height. The area thus enlarged will be 253 acres, equal to 140 acres 35 feet

deep ; and 113 acres 15 feet deep ; making a total of 287,278,200 cubic feet of water."

This reservoir has been completed and in operation for some years.

Reckoning the interest of the money expended upon the works, the cost of maintenance, and the expenses of superintendence and distribution, the annual charge amounts to £700 ; and it is calculated that 33 tons of water are supplied for one shilling ; and as 12 cubic feet per second falling one foot is a working horse power, the value of such an improvement may be estimated.

12 cubic feet at $62\frac{1}{2}$ lb. = 750 lb. \times 60 sec. =

45,000 lb. falling one foot per minute ;

33,000 lb. raised one foot high per minute, being an effective horse power.

12,000 lb. remaining are allowed for the difference between power and effect.

The Shaw's Water-works are even more interesting. The want of water had been long and grievously felt in the town of Greenock, where the people had not a sufficient supply even for domestic use, and it was generally believed that water sufficient even for sanitary purposes could not be obtained in that locality, until a survey was made by Mr. Thom, who reported, that not only might an ample supply be provided for the use of the inhabitants, but that a large surplus would be applicable as mechanical power and for manufacturing purposes, "to an extent at least equal to all the machinery then impelled by steam-power in and about Glasgow."

The report is dated June 22nd, 1824, and the copy from which the author extracts this information was given to his valued friend, the late James Smith, of Deanston, in August 1840, by Mr. Thom himself, who has in his own handwriting noted the few differences between the original plan and the actual execution of the works.

In consequence of this report, and under the auspices of Sir Michael Shaw Stewart, a joint-stock company was formed for carrying the plan into effect with a capital of £31,000, and an Act of Parliament was obtained.

In April 1827 the principal portions of the works appear to have been completed, namely, the great reservoir containing 284,678,500 cubic feet of water, and covering about 295 statute acres of land. The compensation reservoir, containing 14,465,900 cubic feet, and covering about 40

acres, and an auxiliary reservoir (marked No. 3 upon the plans) holding 4,652,800 cubic feet, with an area of ten acres.

Five other smaller reservoirs are about to be made, and extended to hold more than six millions of cubic feet, so that the aggregate quantity stored at once would be 310,000,000 cubic feet of water. The embankment of the great reservoir is 60 feet high, and that of the compensating reservoir 23 feet.

The main water-course, somewhat more than six miles in length, was at the same time completed, and also its branch leading to the eastern line of mills, there being two lines, east and west, and on the 16th of April 1827 the first mill received its supply of water at the rate of twelve hundred cubic feet per minute; at this rate both lines of mills are supplied. The available annual quantity of water to replenish the reservoirs is more than seven hundred millions of cubic feet.

The distinguishing characteristics of "this scheme" as Mr. Thom calls it, are the following:—Instead of erecting mills and factories on natural waterfalls, on the banks of rivers, in remote and almost inaccessible places,—where immense capital must in the first instance be expended in forming roads and houses for the work-people, as well as a heavy and perpetual charge for carriage to and from the seat of trade,—the water is carried by a conduit from the reservoirs, to a populous seaport town, with a redundant unemployed population, where roads, harbours, piers, and everything requisite for the most extensive manufacture are already formed. Besides, by thus forming artificial waterfalls on advantageous grounds, every inch of fall from the reservoir to the sea is rendered available, whereas by the former mode only a very small part of the fall could in general be employed. In the present case a fall of 512 feet has been made available, of which not more than 20 were formerly occupied or thought capable of being usefully employed. But besides the advantage thus gained by increasing the fall, a still greater advantage is gained from the greatly increased and perfectly uniform supply of water, by the adaptation of the various self-acting sluices, and other simple and effective means of regulation.

The reservoirs are large enough to contain a full supply for six months, so that the surplus of a wet year may be stored up, to provide against a dry season; thus turning

to account all the water caught upon the surrounding hills, the greater part of which before ran wastefully to the sea.

The practical effect of the Shaw's Water-works has been to place within the suburbs of a populous town a series of mills and factories driven by power equal to that of thirty-three steam-engines of fifty horses each.

Such power being applied to manufacturing purposes, each factory will pay in wages to the work-people about £10,000 a year, making a total annual amount distributed in wages only of more than £300,000, and employing upwards of 7000 persons, besides giving an ample supply of water for the use of the town.

A greater addition to the wealth of a small community, in so short a time, and by such simple means, can scarcely be imagined.

CHAPTER V.

RAIN-GAUGES AND RESERVOIRS.—EMBANKMENTS AND THEIR CONSTRUCTION.

THE recognised importance of noting and registering the fall of rain, and of observing other meteorological changes during the year, has led to the establishment of such registers in several towns where scientific institutions or libraries have been formed; but as there are many localities where no observations are made and registered, and as the fall of rain is much affected by local circumstances, many engineers have found it necessary, especially in remote and mountainous parts of the country, to institute a series of observations for their own information, previous to their designing or advising the construction of important works, particularly reservoirs, catch-water drains, and embankments to retain the water falling among the hills, and to store it, either for the supply of towns, for sanitary purposes, or as a means of obtaining mechanical power.

The water supply for the populous and rapidly increasing capital of the cotton manufacture, Manchester, and its neighbourhood, has led to many local observations among the ridges of hills, within reach as it were of the town (or city as it may now be termed), where it was supposed a sufficient area of high and sloping ground might be found

to catch the rain, and afford the requisite water shed, from which a supply might be gathered in the rainy months, and stored for use in dry weather.

Although much pains was taken to arrive at correct conclusions, great discrepancies appeared in the results obtained by persons whose character and standing in the profession warrant the belief that their only aim was to arrive at the truth. Much of the difference arose, doubtless, from the different elevations at which those observations were made; much from the formation of the country, some spots being sheltered from prevailing winds, others exposed to the blast driving the rain in masses before it, and some where the eddying wind threw it down in streams, excessive even in that rainy district.

But besides all these causes of difference between the observers, it was found that even on the same ground the results were not the same; and in these cases the rain-gauges were not like each other.

Without reviving a controversy in which personal feeling sometimes prevailed over scientific discussion, it may be mentioned that some of the rain-gauges used were of the old construction; wherein the rain is caught in a funnel, received in a tube, and measured by a staff or graduated rod, by dipping it into the tube and noting how much of it is wet, or by the rod rising with a float as the rain-gauge fills.

It is obvious, that when this staff was left in the instrument, projecting, as sometimes happened, considerably above the dish or funnel head of the instrument, it caught the drifting rain; and as the wind was violent or otherwise, so were the results affected: thus they varied from the neighbouring rain-gauges, which had no staff, and where the quantity of water contained in it was either read off in a graduated glass tube attached to the instrument, or poured into a separate measuring glass.

It may be said that such errors might readily have been avoided by a little more care and judgment, and something like uniformity of system in the construction and position of instruments, and the time and method of observing; but it must be remembered that such observations were generally undertaken either by individuals, or by a few persons who paid their own expenses; that the engineer was often obliged to depute his pupil or assistant to organize, among the natives of the hills, an extemporary

body of observers, by whom his instructions were hardly understood, even when he flattered himself he had made them very clear and explicit.

The author has before him a series of tables, the "Collected observations, magnetic and meteorological, made throughout the extent of the empire of Russia, and published annually by order of his Imperial Majesty Nicholas the First." These observations, printed in French, are made by the engineers of the mining corps, at their several stations; and they are so copious and exact, that except the observations made at Greenwich under the astronomer royal, and perhaps those at the universities, few registers kept in England will bear comparison with the Russian tables. The rain-gauge used is composed of two cylindrical vases of copper, placed one above the other, and communicating by a small tube; the upper vessel is open at the top, and is larger in diameter than the under one. The rain water received in the upper vessel passes through the pipe into the closed receiver below, whence it is drawn off by a tap into a wide-mouthed tubular glass measure, graduated in equal divisions. The rain-gauge is filled with water, until it rises in the upper cylinder to a point marked beforehand, and then the water is drawn off by the tap until it has fallen an inch. It is received in the cylindrical measuring glass as it runs out of the lower copper vessel; and if it fill this glass $13\frac{1}{2}$ times, its total capacity being $\frac{1}{135}$ of an inch, or 0.074 in depth of the upper vessel, it is only necessary to divide the glass into $7\frac{1}{2}$ parts, to show the hundredth part of an inch of rain.

Twice a day the quantity of rain or snow that falls is noted and registered, that is at 8 o'clock, morning and evening; except in case of a heavy shower, when the time, the duration, and the quantity of rain fallen are also noticed, along with the half-day's downfall, and a corresponding remark made.

In winter the rain-gauge is taken into a warm room every twelve hours, to melt the snow or hail received in it, and a second instrument immediately put in its place; every station being provided with two rain-gauges for this purpose.

It is obvious that such instruments as these may be readily managed by private soldiers, and that correct results may be obtained without much nicety of construction, and without much regard being paid to any of the dimensions, except the divisions of the measuring glass.

A very simple apparatus has been found useful by the

author, where a better could not readily be obtained. Let a tin funnel be made in the form of a shallow cylinder, or hoop, of $13\frac{1}{2}$ inches in diameter, equal in area to one superficial foot, and having the bottom conical, with a pipe of small diameter in the centre, say three quarters of an inch or thereabouts: fit this pipe into the neck of a bottle (a stone-ware bottle is better than a glass one), and let it reach nearly to the bottom of the bottle; put in a little water until it rises above the end of the pipe, to close and seal it so as to prevent loss by evaporation, and the rain-gauge is ready for use.

Weigh the whole apparatus and note the weight; then set it to receive the rain that may fall with the bottle sunk in the ground, and as the top or mouth of the funnel is one superficial foot in area, and a cubic foot of water weighs 1000 ounces, every ounce of water received in the bottle is one-thousandth part of a foot in depth of rain fallen.

One of the most approved rain-gauges has a funnel similar to the last, also a foot in area, mounted on a stand-pipe which receives the water, which should be carried down to the bottom by a slender tube trapped with water at the end, and the stand-pipe has a suitable base or foot. The rain received in the pipe is read off by means of a small graduated glass tube fixed to its side and communicating with it. If the stand-pipe's section be one-tenth of a superficial foot in area, and the glass be divided decimally, every inch of water in the glass will indicate one-tenth of an inch of rain; or the glass may be graduated by trial to suit the stand-pipe.

A convenient portable rain-gauge is also made which answers sufficiently well for temporary purposes, and shows the quantity of rain fallen with tolerable accuracy. It is made of japanned tin, something like an ordinary coffee-pot, and is surmounted with a funnel equal in area to one-fourth of a superficial foot. The water it receives is poured into a graduated measuring glass, whose diameter or section is so proportioned to the area of the funnel as to indicate the depth of rain in inches and decimals, or the glass may be marked in the same way as those used at the Russian stations before described.

It is better to use any of these modes than a measuring rod or staff, which often gives incorrect results; and the rain-gauge should be set with the mouth of the funnel exactly in a horizontal plane or level, and not exposed to blasts or eddies of wind, nor sheltered from the ordinary

breezes, so that its position may correspond with the general surface of the locality and catch a fair average of the rain.

The rain-gauge recommended for local observations by Mr. James Glaisher, F.R.S., Secretary to the British Meteorological Society, is a simple cylindrical vessel, eight inches in diameter and thirteen inches high, sunk in the ground eight inches, and consequently having the top edge five inches above the ground. Into the top or mouth of this vessel is fitted a funnel, formed of a plain inverted cone six inches deep, the apex of the cone ending in a bent tube of an eighth of an inch in diameter, bent so as to form a trap and prevent evaporation, but yet discharging the water freely into the vessel below. For measuring, he recommends a tall cylindrical glass holding one inch of rain as received in the gauge, and divided into ten parts, which may again be sub-divided into ten by using a scale.

Fig. 6.

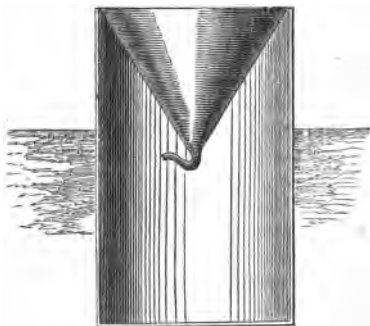

It is due to Mr. Glaisher, to state that having noticed the great want of an accurately kept series of observations of atmospheric and meteoric changes in this country, he has sedulously devoted himself to the establishment of local observatories throughout the kingdom. He furnishes the observers with formularies, he directs them in the selection of instruments, and he visits their localities if needful. He thus interests others in the same useful labours he himself pursues, and he has succeeded in inducing the librarians and secretaries of literary and scientific institutions, mathematical instrument makers and private gentlemen to institute observations of this kind on one general and uniform system. They transmit to him printed forms filled up, and he arranges

and tabulates them. Such works as these cannot be too highly commended; and as the farmers' crops and land-owners' rents depend on these changes, they will do well to observe them also.

Having thus shown how the rain may be measured by the gauge and collected in the reservoir, confined by embankments and regulated to supply the required power to turn the mill and substitute mechanical force for manual labour, let us not forget the old and homely proverb, that "Fire and water are good servants, but they are bad masters."

The weight of a cubic foot of water being $62\frac{1}{2}$ lb., it presses with that force upon the square foot of surface on which it rests, and every foot in the depth of water adds that force to the pressure; so that if the depth of a reservoir be 54 feet, every square foot of ground at the bottom sustains a pressure of $62\frac{1}{2} \times 54 = 3375$ lb., or somewhat more than a ton and a half. What care then must be necessary in preparing a large area to resist such a weight, and render it secure under such a pressure!

But it is not only in a vertical direction that the pressure of a fluid acts: it thrusts against the embankment with a general force over the whole surface, equal on the perpendicular line to half the depth of the liquid column, in a lateral direction, tending to force it from its place; and if the mound or dam crossing the valley be 600 yards in length or 1800 feet, with a depth of 54 feet of water against it, the whole lateral thrust will be, taking it at half the above perpendicular pressure, more than 83,000 tons; while the lateral pressure exerted at the foot of the embankment is equal, or nearly so, to the perpendicular force.

Fig. 7.

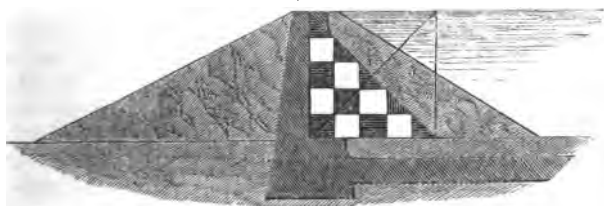

DIAGRAM TO SHOW THE PRESSURE OF WATER AGAINST AN EMBANKMENT.

These dimensions are not hypothetical; the author was for many years in the habit of walking, almost daily, along such an embankment, and he has seen it at times severely tested.

Let it be remembered that in such situations a bed of alluvial soil often rests upon clay, with water oozing between them, and that the beds in such situations slope in the direction of the valley, and consequently in that of the thrust. This is no uncommon case, and unless the greatest judgment and foresight be exercised in forming such dams in the outset, they may sooner or later yield to the enormous force pressing against them, and carry ruin and devastation with them.

The author has seen railway embankments, hastily raised to cross the valley, where an inclined substratum of clay, lurking as it were beneath, intercepted the surface water, and caused an insidious and slippery parting in the measures, slide as if they had been launched, for several yards, and wrinkling up the green sward, to the dismay and loss of the too clever contractors who risked such an experiment. But in making dams to confine water, nothing will justify such risk; and as this little book may fall into the hands of young practitioners in remote places, the author strongly urges that in constructing such works nothing should be left to chance; that well constructed banks with flat slopes, stout puddle walls and lining, earthwork and masonry sufficiently massive to resist unflinchingly the greatest possible amount of thrust they may have at any time to sustain, should be constructed in all cases; that means of relief and discharge be provided to meet extraordinary seasons; and that both surface and substrata be carefully bored and examined before the works are commenced, and diligently watched during their progress, for great responsibility lies upon the man who attempts, with insufficient means, to restrain a destructive and overwhelming torrent.

CHAPTER VI.

HORIZONTAL WATER-WHEELS AND SIMILAR MACHINES.

THE primitive application of water-power to turn mill-stones has been noticed in the early part of this book, and the employment of horizontal water-wheels, with vertical axles, is still considered by French engineers to be in many cases advantageous, as presenting great simplicity and economy, both in construction, maintenance, and application; as requiring but little space, and in being able to work in floods and in frosty weather.

In driving corn-mills they need no toothed-wheel work, and in besieged towns they can be worked at all times without interfering with the defences, being either placed altogether out of harm's way, or costing but little to shelter them from the enemy's fire.

Such is the opinion of experienced officers of the French artillery, and we are indebted to two of them—MM. Piobert and Tardy—for an elaborate series of experiments and an excellent report on the useful effect of the ordinary horizontal water-wheel at present used in France. Those on which the experiments were made are at Toulouse, where the two dams (*barrages*) of the Garonne, and the abundance of water in the canal of the south, near its discharge into that river, have rendered disposable falls of water sufficient to put in motion a great number of corn-mills by means of horizontal water-wheels. These wheels are of two kinds: those situate on the rivers are called bucket-wheels (*à cuve*), and are similar to what are used at Cahors, at Metz, and other places; those which are placed on the canal are called whirl-wheels (*rouets volants*), and much resemble those which have existed from time immemorial, and are turned by the percussion of the water upon curved floats, which are here used instead of the ladles that are fixed round the axles of the mills of the Alps.

It may here be remarked that in Northern Africa several rude mills are to be found in the same fashion as they have existed for ages, among a people the least advanced in the arts of industry; many of them are on the great falls of the

Rummel at Constantineh, and instead of ladles these have pieces of wood rudely driven into the upright axle, like spokes into the nave of a cart-wheel. A channel being made from the river, at an inclination of 30 or 40 degrees, the water is directed against the side of the wheel, and having done its work it is returned to the river and employed again and again as it descends the hill to turn a series of such mills. In some of these the upper end of the vertical axle is fitted with a bent arm or crank, and the millstone, which, in such cases, is fixed in an inclined position of 10 or 15 degrees to the horizon, is forced round by it. With these mills they prepare the coarse meal, which, being cooked in steam, makes the "couscousou," the common food of the natives.

The localities at Toulouse afforded many favourable circumstances for making experiments, besides the general employment of these two kinds of wheels, so that the results of both could be readily and exactly compared by the same dynamometers and other instruments used by the same observers.

The results of all the trials appear to be that on the horizontal water-wheels with buckets the effects produced at ordinary speeds varied from 15 to 27 per cent. of the power employed when the mills and wheels were in good condition. The speeds were varied from 60 to 135 revolutions per minute; but the best effect seems to have been obtained at about 90 revolutions, with a total fall of water, measuring the difference of level above and below the wheel of from seven to eight feet. The wheels were about five and a half feet in diameter; that of the millstones is not stated in the report, but they appear to have been such as are in general use—probably about four and a half feet. The water which drove these wheels was discharged through an ordinary sluice, and passing through a channel of stone-work was thrown obliquely on the wheel.

The other kind of horizontal wheels experimented upon was distinguished by the name of "*rouets volants*," here termed a *whirl-wheel*—for the term fly-wheel, as we now use it, is applied to a very different piece of machinery, namely, the massy cast-iron regulator of steam-engines and other heavy works.

These wheels received the water directed upon them through an inclined pyramidal trunk of wood upon one side of the wheel; the larger end of the trunk being closed,

or the entrance of the water regulated by a sluice, against which was a head of water of fourteen or fifteen feet, to which the inclination of the trunk, or about two feet more,

Fig. 8.—Roue à Cuves.

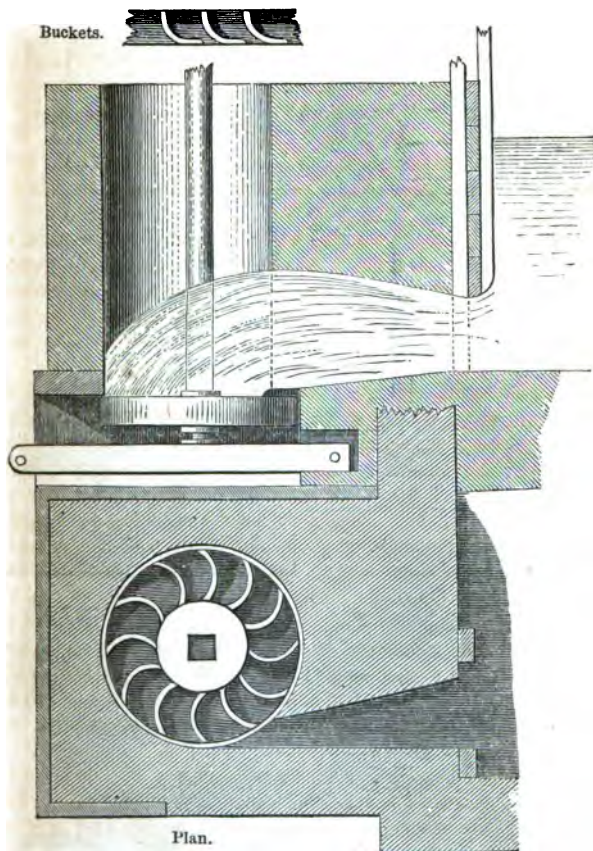

may be added, so that the ladles of the wheel were acted upon by the weight and impulse of the water, and were so formed as to continue such action until the water escaped between them, and passed through the wheel.

When these wheels made 102 and 108 revolutions per

minute, the useful effect was from 29 to 33 per cent., and when the resistance of the work done reduced their speed to 90 and 85 turns per minute, their effect reached to 39

Fig. 9.—Rouet Volant.

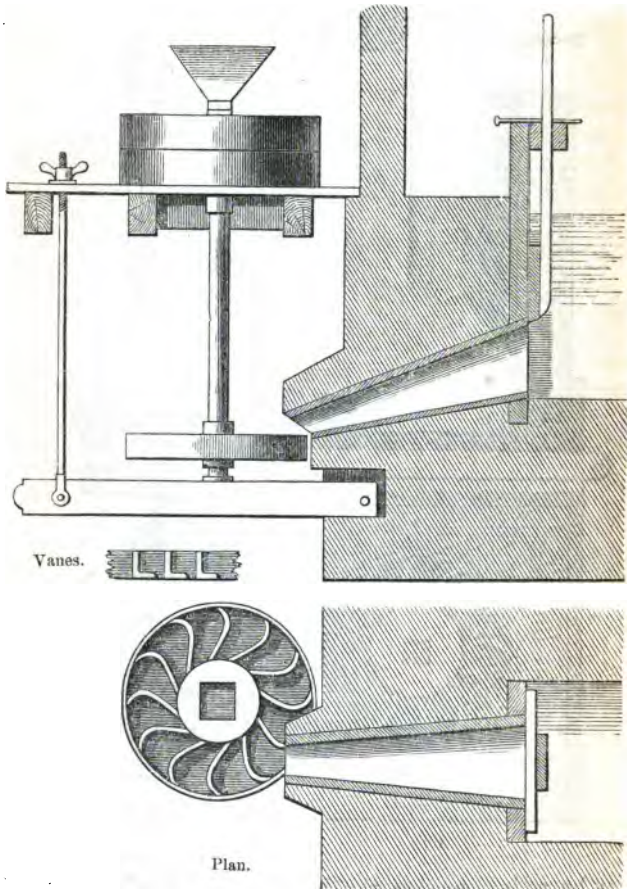

and 40 per cent. of the power expended, the useful effect of these wheels being nearly the same as that of the old under-shot water-wheel.

The difference in construction between the two kinds of mills appears to be very slight, and their dimensions and cost to be the same or nearly so; but the supply of water being abundant, the millers paid no attention to the quantity expended in performing a given amount of work. (See Fig. 9.)

The wheels are made of cast iron, and the pivot of the upright shaft stands upon a foot-bridge or lever, fixed at one end, and regulated at the other end by a second lever placed in the mill above, so that the millstones may be adjusted to grind closer or otherwise in the usual way.

It is perhaps impossible to construct a more simple and less expensive corn-mill, where plenty of water is at hand to drive it, and the author has been somewhat diffuse in explaining it, as there may be many localities, especially in New Zealand and other colonies, where such simple and cheaply made mills would be of great advantage to a small community of settlers.

It is however well known to all experienced millwrights, that a much greater amount of useful effect is obtained when water acts by its gravity or pressure than when it acts by its impulse; and it has been found expedient in some places, where the millers desired to retain the horizontal wheel and to economise the expenditure of water, to vary its construction, so that the weight of the water should act, and that without impulse.

This has been effected by using as it were two wheels, one laid upon the other; the upper wheel being fixed and immovable, and serving only to direct the water against the vanes or buckets of the lower wheel, which is forced round by the pressure so directed against it.

A drawing of such a mill, the wheel 5 feet in diameter, constructed in Italy, has been kindly forwarded from Genoa, and shows the next improvement made in this useful machine. It is known in France and Germany as Koechlin's plan, and is sometimes wrongly called his turbine.

A cylinder is formed of cast iron, wrought-iron plates, or wood strongly hooped, and is made open at the top, unless the millstone rest upon it when the power is used to grind corn. The upper end of the cylinder is somewhat higher than the head of the column of water intended to act upon the wheel, the water entering it through an opening on one side, and the internal diameter as proportioned to the quantity of water to be used; there is a sluice to regulate

Fig. 10.

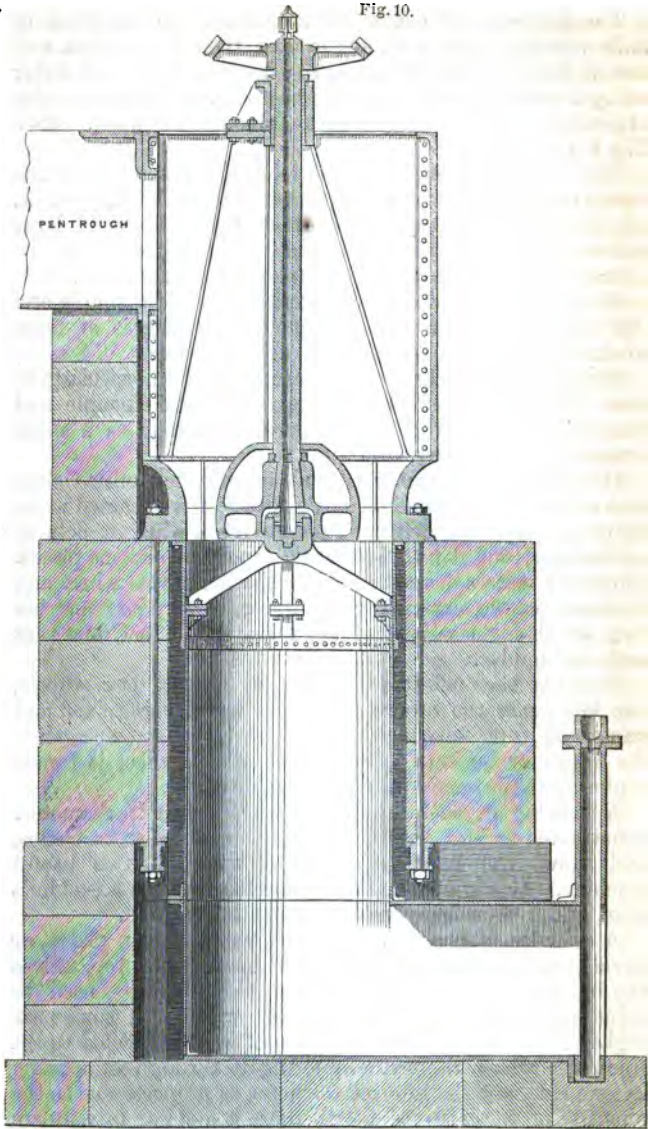

SECTIONAL ELEVATION.

the supply at top, fixed in the pentrough, and another at bottom which regulates the expenditure; the pressure of the atmosphere on the top is supposed to render the whole column effective. The fixed wheel forms a bottom to the upper portion of the cylinder, which must be firmly secured to a foundation of masonry or timber. The upright shaft or axle is fitted into the moving wheel and turns with it, passing through a collar properly bored and lined with brass, in the centre of the upper or fixed wheel; it is steadied and secured by another collar formed on a frame or bracket, screwed to the top of the cylinder, which may be dispensed with if the nether millstone be used instead; but, in the sketch here given, the wheel is intended to turn other kinds of machinery.

It will be observed that, in the present instance, the upper portion of the cylinder, above the fixed wheel, is made of cast iron, and that the lower part is made of wrought-iron plates. The pressure of the water is directed by the vanes or guide-curves of the upper wheel into the buckets of the lower one, so as to bear upon them with the greatest effect, while, by the regulation of the two sluices (which are not shown in the woodcut), the cylinder is kept full, and the descending column of water passes like an eddy through the wheels, with a force proportioned to the whole height, for the lower end of the cylinder is immersed in the water, which in ordinary times just covers the outgoing opening, and in flood times rises above it, so that the power due to the difference between the surfaces of the dam and the tail water may always be available.

Fig. 11.

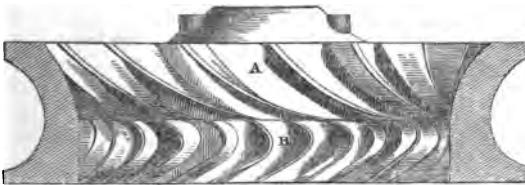

SECTION.

A. The fixed part with guide curves. B. The revolving part or wheel with its buckets.

Fig. 12.

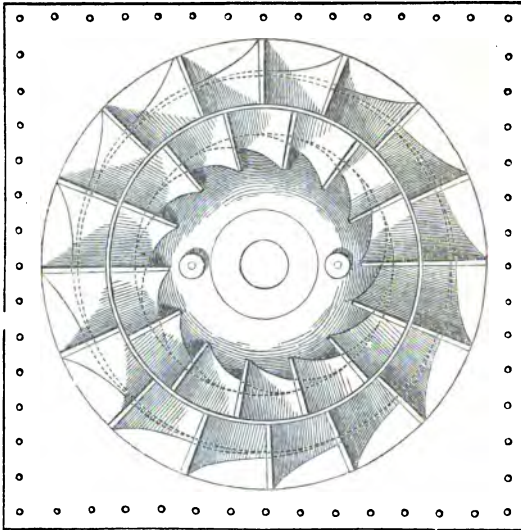

PLAN OF FIXED PART WITH GUIDE CURVES.

Fig. 13.

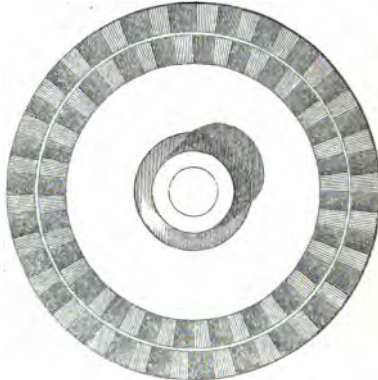

PLAN OF REVOLVING PART WITH BUCKETS.

This combination is a great improvement upon the wheels at Toulouse, before described ; and the same principles have been further developed by MM. Fromont, who obtained

the Council medal, at the Great Exhibition of 1851, for their Horizontal Water-Mill of fifty-five horses' power, constructed on the system of M. Fontaine Baron—a machine capable of the nicest adjustment, and applicable to any manufacture, however delicate, as the spinning of silk and fine yarns of any kind, and giving a useful effect of 75 per cent.

In several respects this resembles the last-described, inasmuch as there are two wheels placed in the same manner, either at the lower end of a large iron cylinder open at the top, or at the bottom of a cistern of strong woodwork. The reservoir or cistern intended to be used for this wheel was about 8 feet high, but it was not exhibited, as it would have prevented a complete view of the interior arrangements. It was therefore removed, and the upper work for regulating the sluices, together with the governor, were placed on a cast-iron frame above, supported by six pillars. The upper, or fixed wheel, had a strong flanch surrounding it and cast with it, having provision made for securing it with screw-bolts to the bottom of the cistern or tank, and beneath the revolving, or under wheel (in this case not included in a cylinder, as in Koechlin's plan); a clear way of escape for the effluent water, after it had done its duty, was left on all sides. The fixed wheel, thus attached by its flanch to the bottom of the tank, was about $6\frac{1}{2}$ feet in diameter, and had a strong cast-iron pipe, about a foot in diameter, fixed by bolts to its centre, and rising up above the level of the cylinder or cistern, where it was secured by a strong frame, serving to bind together the whole fabric and to support the axis of the revolving wheel which passed through the pipe and worked in a gun-metal collar above.

In the fixed wheel there were forty-two openings disposed in two concentric circles; the outer circle having twenty-four, and the inner circle eighteen; these openings radiated from the centre of the wheel, and were formed so as to direct the water into the buckets of the revolving wheel below it. The outside diameter of the outer circle of openings was about $6\frac{1}{2}$ feet, and the inside diameter of the inner circle about $3\frac{1}{2}$ feet; there was a division, or partition of an inch in thickness, between the two circular series of openings, so that they might be about $8\frac{1}{2}$ inches long.

Each of these openings was fitted with a sluice made of cast iron, with the back of it properly curved in a vertical direction, so as to direct the water in passing through the openings and lead it fairly into the buckets.

Fig. 14.—Sectional Elevation.

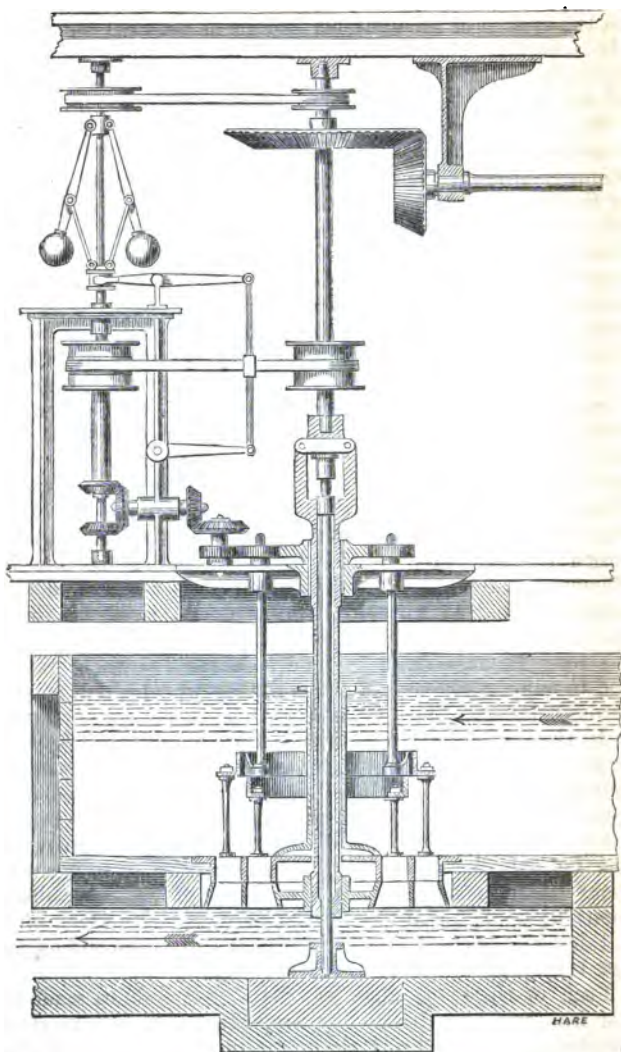

Every one of these sluices is suspended and attached to a wrought-iron rod, about an inch in diameter, screwed into the sluice, and standing up about 18 inches. On the top of these rods is secured a strong flat ring; the rods are fitted with collars, screws, and nuts to fasten them into the ring, or rather rings, for there are two: that is to say, one for the outer, and one for the inner circle of sluices and openings.

Each of these rings is suspended by three strong round rods, with regulating screws cut upon them, so that by means of wheel-work the two circles of sluices can be simultaneously raised and opened, or lowered and shut, at pleasure; or the openings may be enlarged or contracted, to regulate the speed of the machine, by adjusting the discharge of water through them; and this regulation is effected by a conical pendulum or governor similar to that of the steam-engine.

This apparatus of MM. Fromont has been improperly termed a turbine, by which is understood some wheel resembling the shell so called, and working by reaction; but it will be clear, from the foregoing details, that it was, in fact, a horizontal water-wheel, in the construction of which great ingenuity and mechanical skill were displayed.

In awarding the council medal to this machine, the jury mentioned the advantages possessed by it, and by similar well-constructed horizontal wheels and turbines, of frequent use in France, but almost unknown in England.

First,—That they occupy a small space. *Second*,—That turning very rapidly, they may, when used for grinding flour, be made to communicate the motion directly to the mill-stones. *Third*,—That they will work under water. *Fourth*,—That they will work equally well under small and great falls of water. *Fifth*,—That they yield when properly constructed, and with the supply of water for which they have been constructed, a useful effect of from 68 to 70 per cent.; being an efficiency equal to that of any other hydraulic machine. *Sixth*,—That the same wheel may be made to work at very different velocities, without materially altering its useful effect.

This last property is one of great importance in certain applications, and constitutes an advantage of this machine over most others that have their established rates of working, from which it is not possible to deviate without a proportionate sacrifice of power.

The wheel of M. Fontaine Baron, made by MM. Fromont

Fig. 15.

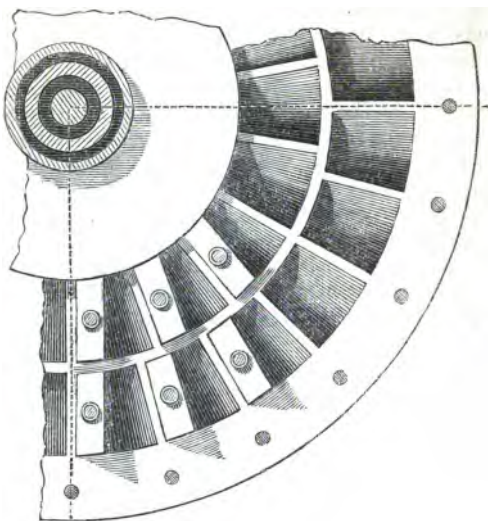

Plan (one-fourth) of the fixed part, showing the Guide Curves and six of the Sluces or Regulators.

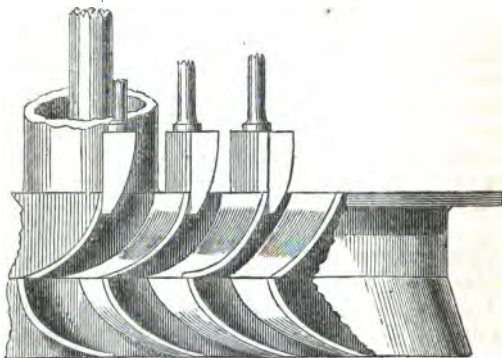

SECTIONAL ELEVATION, broken to show the form of the Guide Curves with three of the Sluces; also the form of the Buckets in the wheel below.

and Son, appears, from experiments made on its efficiency, to be one of the most successful modifications of that form introduced into France by Fourneyron, in place of the old horizontal water-wheel.

There is another simple and useful water-wheel used by the French in Guienne and Languedoc, sometimes called *Roue à Poire*, or the pear-shaped wheel. It is also a horizontal wheel with a vertical axis; and when the power required is not great, the water plentiful, and the means of construction limited, it may often be adopted with advantage. It consists of an inverted cone, with spiral float-boards of a curvilinear form, winding round its surface. This wheel revolves on a pit or well of masonry, into which it fits pretty closely, like a coffee-mill in its box. The water, conveyed by a spout or trunk, strikes the oblique float-boards, and, when it has spent its impulsive force, it descends along the spiral float-boards and continues to aid by its weight until it reaches the bottom, where it is carried off by a canal. There is considerable ingenuity in this contrivance; for the jet of water being first applied to the upper, or largest part of the cone, strikes the float-boards at the point where they move with the greatest speed, the radius there being longest; but as the water loses its velocity, in consequence of the motion it has imparted to the wheel, it descends in the cone and acts upon the floats lower down, where, the radius being less, they move more slowly; and the water is still beneficially employed until it quits the wheel.

It is perhaps not necessary to describe the Danaide of M. Dectot, nor the Conchoidal-wheel of Euler, as neither of these are in use, excepting so far as to notice that, in the first of these, the water acts in a narrow annular channel, at the circumference of the machine, formed between a hollow external and a solid internal drum, which is also shallower than the outer one, and that it is projected into this hollow ring or channel by inclined spouts, or jets forming tangents to its circle, so as to drive it round, after which it goes out at the centre, through passages suitably formed, so as to continue the effect of the water as long as it remains in the wheel.

In designing the conchoidal wheel, the inventor seems almost to have discovered, the reactionary effect of the effluent water, which has since been made available in the turbine, that is to say, the unbalanced pressure opposite to the orifices, impels the wheel somewhat in the same way

that a sky-rocket is driven through the air in its rapid flight, by the force or recoil acting against the closed end of the rocket tube or case. It does not appear, however, that this horizontal wheel was ever made practically useful.

CHAPTER VII.

TURBINES, AND THE REACTION OF WATER PRESSURE ON WHEELS, ETC.

WITHIN the present century, a new mode of applying the power of water to produce circular motion has been introduced, and of late years it has attracted much attention, and received many improvements: hitherto it has been but little used in England; but in Germany, in France, and in America, it has been very successfully employed.

It is chiefly to German engineers and mathematicians that we owe the investigation of the principles on which the turbine is constructed, and the best methods of reducing them to practice. The French, also, have been prompt to appreciate the value of the turbine: M. Arago has given his testimony as to its merits, and other French writers of note have examined it in detail; but we have no complete work in the English language, except a translation from the German of Professor Moritz Ruhlmann, edited by Sir Robert Kane, and rendered valuable to practical men by his observations.

In order that the subject of this chapter may be better elucidated, and traced from its first elements, it may be proper to notice the philosophical toy which figures in many works on hydrostatics and hydraulics, as Dr. Barker's mill, but is by most persons passed over as a mere plaything, useless for practical purposes; it involves, however, principles of action which, when well and scientifically carried out, lead to most important results.

Dr. Barker's mill consists of an upright pipe or tube, with a funnel-shaped open top, but closed at the lower end; and from the lower end project two horizontal pipes or arms, also closed at the outer ends, and placed opposite to each other, at right angles with the vertical tube, so as to form a cross. Near to the end of each horizontal pipe, and on

one side of it, is a round hole, the two holes being opposite to each other. The upright pipe is mounted upon an axis or spindle, and is kept full of water flowing into the top.

The water, issuing from the holes on the opposite sides of the horizontal arms, causes the machine to revolve rapidly on its axis, with a velocity nearly equal to that of the effluent water, and with a force proportionate to the hydrostatic pressure given by the vertical column, and to the area of the apertures; for there is no solid surface at the hole on which the lateral pressure can be exerted, while it acts with its full force on the opposite side of the area. (See Fig. 16.)

Fig. 16.

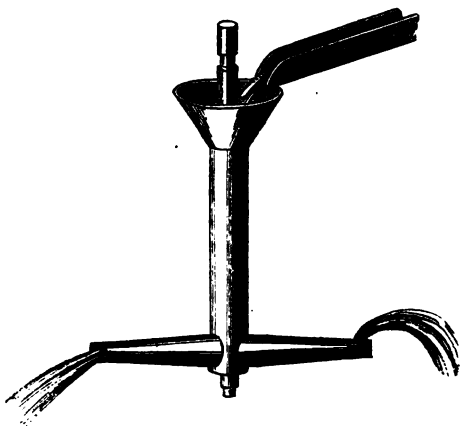
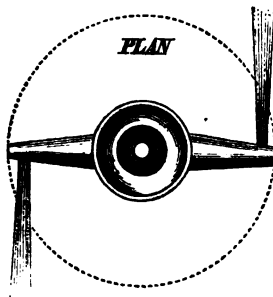

Fig. 17



This unbalanced pressure, according to Dr. Robison, is equal to the weight of a column having the orifice for its base, and twice the depth under the surface of the water in the trunks for its height.

This measure of the height may seem odd, because if the orifice were shut, the pressure on it is the weight of a column reaching from the surface. But when it is open, the water issues with nearly the velocity acquired by falling from the surface, and the quantity of motion produced is that of a column of twice this length, moving with this velocity. This is actually produced by the pressure of the fluid, and must, therefore, be accompanied by an equal reaction.

When the machine, constructed exactly as before described, moves round, the water which issues descends on the vertical trunk, and then, moving along the horizontal arms, partakes of the circular motion.

This excites a centrifugal force, which is exerted against the ends of the arms by the intervention of the fluid.

The whole fluid is subjected to this pressure, increasing for every section across the arm, in the proportion of its distance from the axis; and every particle is pressed with the accumulated centrifugal forces of all the sections that are nearer to the axis; every section, therefore, sustains an equal pressure, proportional to the square of its distance from the axis. This increases the velocity of efflux, and this increases the velocity of revolution; their mutual co-operation would seem to terminate in an infinite velocity of both motions; but on the other hand, this circular motion must be given even to every particle of water, as it enters the horizontal arm. This can only be done by the motion already in the arm, and at its expense. Thus there must be a velocity which cannot be over-passed, even by an unloaded machine. But it is also plain, that by making the horizontal arms very capacious, the motion of the water to the jet may be made very slow, and much of this diminution of circular motion prevented.

Dr. Désaguiers, Euler, John Bernoulli, and M. Mathon de la Cour, have treated of this machine; and the latter author proposes to bring down a large pipe from an elevated reservoir, to bend the lower part of it upwards, and to introduce into it a short pipe with two arms like Dr. Barker's mill reversed, and revolving on an upright spindle in the same manner; the joint between the two pipes being so

contrived as to admit of a free circular motion without much loss of water. By this arrangement, a fall or column of water of any height, however great, may be rendered available. This arrangement was proposed in 1775. Some few years ago, Mr. James Whitelaw, of Paisley, attempted the improvement of this machine, and took a patent for his improvement, of which he published an account in 1845. This would seem to consist chiefly of the modifications recommended by Dr. Robison and M. Mathon de la Cour, and of the bending of the two horizontal arms into the form of the capital letter S: the water being discharged from the ends of the arms, in the direction of the circle traced by their revolution, or in that of a tangent to it. The curvature is that of an Archimedean spiral, with the extremity of the arm or jet piece continued for a short distance in a circular curve, coincident with the circle described by the end of the arm. The utility of this continuation, however, seems to be questionable.

The wood-cuts show the method of striking the spiral curves to form the arm and a section of the machine.

Fig. 18.

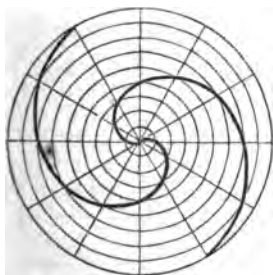
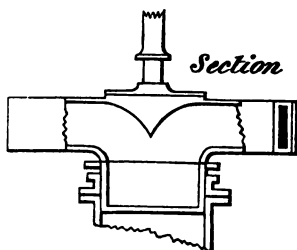

Fig. 19.



The capacity of the hollow arms is increased as they approach the centre of rotation, so as to contain a quantity of water at every section of the arm inversely proportionate to its velocity at that section, so that little of the centrifugal force may be lost. The engravings show an elevation and plan of Mr. Whitelaw's machine, and the method he proposes for forming the arms. The curvature is that of an Archimedean spiral, with the extremity of the arm or jet piece continued for a short distance on a circular curve. The utility of this continuation, however, seems somewhat doubtful.

The sections of the arms are everywhere parallelograms of equal depth, but of breadth increasing from the jet at the extremity of the arm to the centre of the machine. (See fig. 20.)

A model water-mill of the form shown in these figures, working with a fall of 10 feet, the diameter of the circle described by the arms being 15 inches, and the aperture of each jet 2·4 inches in depth by ·6 of an inch in width, the area of each orifice being 1·44 inches; the expenditure of water was 38 cubic feet, the velocity 387 revolutions per minute, and it gave an effect equal to 73·6 per cent. of the power employed.

Mr. Whitelaw states that the machine is most effective when the jets or ends of the arms revolve with a velocity equal to that acquired by a heavy body falling through the height of the vertical column.

The model used in this instance was well made and the experiments carefully conducted, but Mr. Whitelaw states that he has obtained nearly equal results in actual practice on the large scale.

It will be observed that in the employment of water of considerable altitude, a great force will be exerted against the moving part of the machine, tending to lift it up from its seat; it has therefore been proposed by M. Redtenbacher,

Professor of Mechanism at Carlsruhe, to obviate this inconvenience when high falls are used, by making the axis horizontal and fixing upon it two machines, introducing the water between them by means of a pipe formed like the letter T; so that equal pressures acting in opposite directions may counteract and neutralise each other.

Fig. 21.

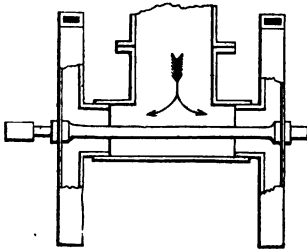

The axis or spindle connecting the two machines, and passing through the transverse pipe, is kept in a state of tension by the diverging forces. (See Fig. 21.)

The author was indebted to Professor Wedding, of Berlin, for the first authentic information he received respecting the turbine, as also for a sketch and the dimensions of one of these machines, then recently erected under M. Wedding's

Fig. 20.

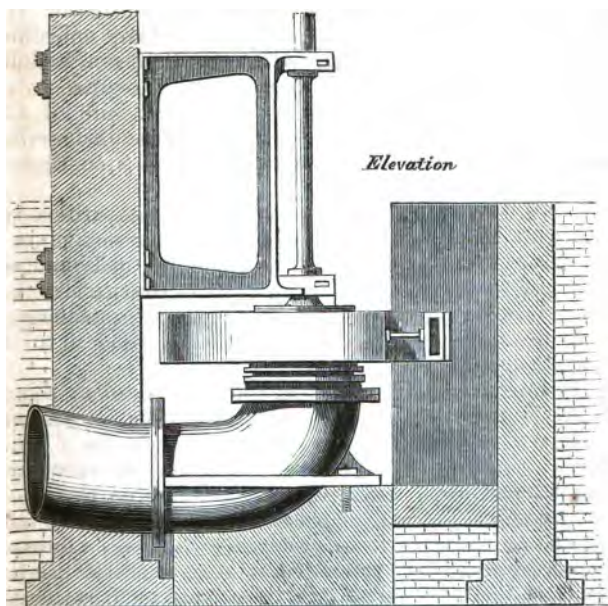

Plan

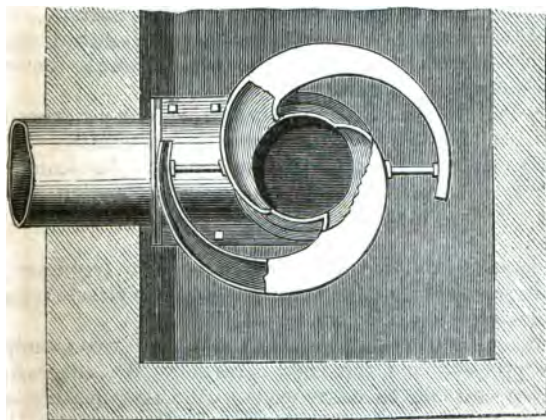

direction. The fall, or rather the head, of water acting upon it was 20 feet, the diameter of the wheel 3 feet 8 inches, the speed 115 revolutions per minute, and the power equal to 42 horses, which drives eight pairs of ordinary millstones, with all the requisite dressing machinery. Professor Wedding afterwards sent the author from Berlin a treatise on this subject which he had written in conjunction with M. Carliczeck, wherein several other similar machines are described, and the useful effect of the water is stated at from 68 to 80 per cent. (See Fig. 22.)

It will be seen that the great value of the turbine consists in its being applicable to falls of water so high or so low that an ordinary water-wheel cannot be used; and also that in falls of great height the velocity of the machine is so rapid, that when applied to drive spinning machinery, it needs no mill work, or but very little, to bring it to the requisite speed.

The invention of the turbine, properly so called, belongs to M. Fourneyron, and in its present form it generally consists of a horizontal water-wheel, in the centre of which the water enters; diverging from the centre in every direction, it enters every bucket at once and escapes at the circumference or external periphery of the wheel. The water acts on the buckets of the revolving wheel with a pressure proportionate to the vertical column or height of the fall, and it is led or directed into these buckets by stationary guide curves, placed upon and secured to a fixed platform, within the circle of the revolving part of the machine. The efflux of the water is regulated by a hollow cylindrical sluice, to which a number of stops, acting simultaneously between the guide curves, are fixed.

With this short cylinder or hoop, they are all raised or lowered together by means of screws communicating with a regulator or governor, so that the opening of the sluice and stops may be increased or diminished in proportion as the velocity of the wheel may require to be accelerated or retarded.

This cylindrical sluice alone might serve to regulate the efflux of the water, but the stops serve to steady and support the guide-curves and prevent tremor.

Turbines may be considered as divided into two classes,—the low pressure and the high pressure. The engravings will better explain the construction of these machines and the arrangement of their parts than a longer verbal description.

M. Fourneyron, who began his experiments in 1823, erected his first turbine in 1827, at Pont sur l'Ognon, in France. The result far exceeded his expectations, but he had much prejudice to contend with, and it was not until 1834 that he constructed another, in Franche Comté, at the iron-works of M. Caron, to blow a furnace. It was of seven or eight-horses power, and worked at times with a fall of only nine inches. Its performance was so satisfactory that the same proprietor had afterwards another of fifty-horses power erected, to replace two water-wheels which, together, were equal to thirty-horses power.

The fall of water was 4 feet 3 inches, and the useful effect, varied with the head and the immersion of the turbine, from 65 to 80 per cent.

Several others were now erected: two for falls of seven feet; one at Inval, near Gisors, for a fall of 6 feet 6 inches, the power being nearly forty-horses, on the river Epté, expending 35 cubic feet of water per second, the useful effect being 71 per cent of the force employed.

One with a fall of 63 feet gave 75 per cent.; and when it had the full head or column for which it was constructed,—namely, 79 feet,—its useful effect is said to have reached 87 per cent. of the powers expended.

Another, with 126 feet, gave 81 per cent.; and one with 144 feet fall gave 80 per cent.

At the instance of M. Arago, a commission of inquiry was instituted by the Government of France, and examined the turbine of Inval, near Paris, the total fall of water being 6 feet 6 inches, as has been before mentioned. By putting a dam in the river, below the turbine, so as to raise the tail water and diminish the head to 3 feet 9 inches, the effect was still equal to 70 per cent.; with the head diminished to 2 feet, the effect was 64 per cent.; and when the head was reduced to 10 inches, it gave 58 per cent. of the power expended, notwithstanding the great immersion of the machine.

In the year 1837, M. Fourneyron erected a turbine at St. Blasier (St. Blaise), in the Black Forest of Baden, for a fall or column of water of 72 feet (22 metres). The wheel is made of cast-iron with wrought-iron buckets; it is about 20 inches in diameter, and weighs about 105 lbs.; it is said to be equal to fifty-six horses power, and to give a useful effect equal to 70 or 75 per cent. of the water power employed. It drives a spinning-mill belonging to M. d'Eichtal.

A second turbine, at the same establishment, is worked by a column of water of 108 metres, or 354 feet high, which is brought into the machine by cast-iron pipes of 18 inches diameter of the local measure, or about $16\frac{1}{2}$ inches English. The diameter of the water-wheel is $14\frac{1}{2}$, or about 13 inches English, and it is said to expend a cubic foot of water per second; probably the expenditure may be somewhat more than this.

The width of the water-wheel across the pier is $\cdot 225$ or less than a quarter of an inch. It makes from 2200 to 2300 revolutions per minute; and on the end of the spindle, or upright shaft, of the turbine, is a bevelled pinion, of nineteen teeth, working into two wheels, on the right and left, each of which has 300 teeth. These give motion to the machinery of the factory, and drive 8000 water spindles, roving frames, carding engines, cleansers, and other accessories. The useful effect is reported to be from 80 to 85 per cent. of the theoretical water power. The water is filtered at the reservoir before it enters the conduit pipes; and it is important to notice this, since the apertures of discharge in the wheel are so small as to be easily obstructed or choked.

The water enters the buckets in the direction of the tangent to the last element of the guide-curves, which is a tangent to the first element of the curved buckets. The water ought to press steadily against the curved buckets, entering them without shock or impulse, and quitting them without velocity, in order to obtain the greatest useful effect; otherwise a portion of the water's power must be wasted or expended, without producing useful effect on the wheel. The engravings show a section of this turbine, and a quadrant of its water-wheel, drawn to a scale of one half of the actual size.

It is difficult to imagine that a machine so small as this can give motion to the works of a cotton mill, on so large a scale. Professor Ruhlmann says, that when he saw it actually doing so, he could not, for some time, credit the evidence of his senses; and, although he went purposely to examine it, his astonishment prevented him from comprehending, in the first instance, that the fact was really as it appeared.

There are many places, especially in hilly districts, where high falls of water are found, and where the nature of the ground affords facilities for making reservoirs, so as to

Section.

Fig. 22.

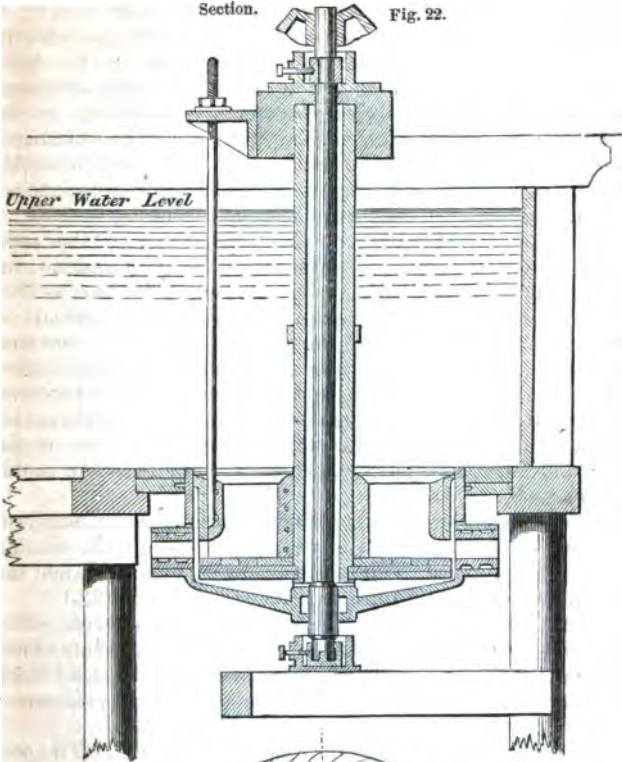

Plan

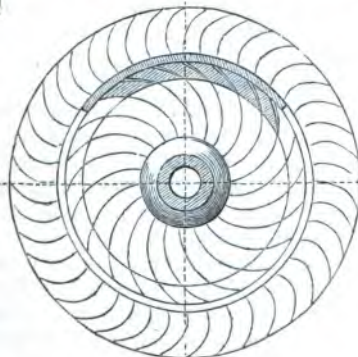

Scale of Feet

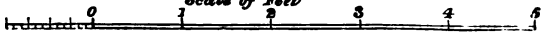

ensure a constant supply, where the height of the column of water may compensate for the smallness of its volume. In such situations it may be conveyed in pipes to the high-pressure turbine, which may often be applied with advantage for grinding corn, working threshing machines, or for crushing ore, and other purposes. There are other situations in which a great volume of water rolls, with but little fall, and it has been shown that, with a head of only nine inches, the low-pressure turbine has done good service.

The illustrations here given, as explanatory of the progress and construction of the turbine, are an elevation and plan of Dr. Barker's mill; an elevation and plan of Mr. Whitelaw's mill; and diagrams, showing the method of striking the spiral curves to form the arms; with a section, showing how the mill is connected with the supply-pipe; the loose collar is pressed upwards against the revolving part of the machine by three bow springs, fixed between the flanches; the collar is prevented from revolving, by a steady pin; and the parts in contact are ground together to be water-tight.

A sectional elevation of a low-pressure turbine, with one of the three screws for raising and lowering the circular sluice (with plan). The screws are connected, and act together, by means of toothed wheels. (See fig. 22.)

Also a plan of the water-wheel, the guide curves, and a portion of the circular sluice. The curved buckets, which are made of thin plate-iron, are screwed against loose blocks or pieces of cast-iron; and these are secured, by means of screw-bolts, within the rim of the water-wheel.

The turbine of St. Blasier, shown in section. The body of the machine is of cast-iron; the wheel is of hammered iron; and the spindle, or axis, of steel. (See Fig. 23.) The letters refer to the same parts on plan. (See Fig. 24.)

The foot of the spindle, and the pivot and step on which it revolves, are tempered to extreme hardness. The oil-pipe at the foot of the pivot is connected with a small force-pump, or syringe, which, at regular intervals, injects a little oil into the step for lubrication. The pump is worked by a slow motion from the machinery.

In all cases it is necessary that the foot of the spindle shall be made hollow, and run upon a fixed pivot. The spindle must never run in a hollow step. The pivot should be quite cylindrical, and it should truly fit the spindle, with as little play as possible; the top of the pivot should be but

Fig. 23.

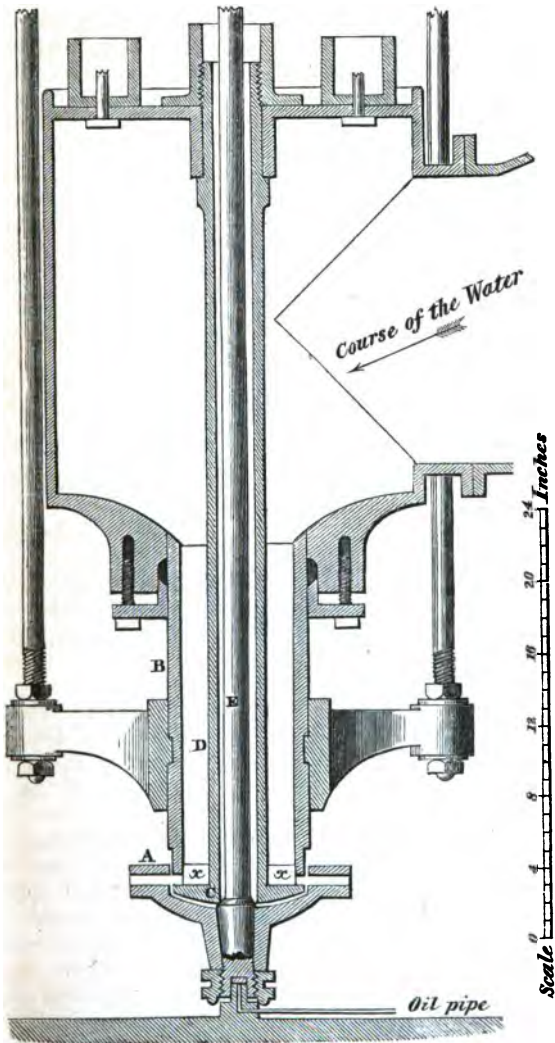

very slightly convex. The water and mud must be carefully excluded, and the parts regularly oiled.

A quadrant or fourth part of the wheel, with the guide curves, and the sluice or regulator of the turbine of St. Blasier. This engraving is one-half of the natural or full size of the machine itself; the bent arrow shows the direction in which the wheel revolves.

Fig. 24.

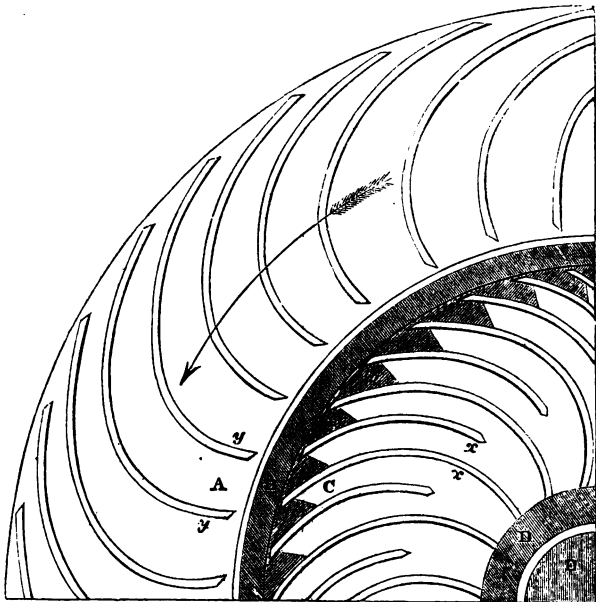

There is also another difference in the construction of turbines which should be noticed. Some have been made which receive the water at their circumference and discharge at their centre. Several of these have been erected in the United States, and have worked very well; but the amount of duty done by a given quantity of water is not so great as when it is admitted at the centre and escapes at the circumference, where it can do so more freely. It is therefore unnecessary to go very minutely into the details of this machine, which is like Mr. Appold's centrifugal pump, so

much noticed in the Great Exhibition, but with its action reversed; so that the pump becomes a water-wheel driven round by the external pressure of the water, like a whirlpool or vortex. (See Fig. 25.)

Some wheels on this principle have been erected near Belfast, with good effect, by Mr. James Thomson, who read a paper respecting them at the meeting of the British Association there. The velocity of these wheels at their circumference was equal to that of a heavy body falling from a height of half the vertical column of water upon the wheel.

Fig. 25. Section.

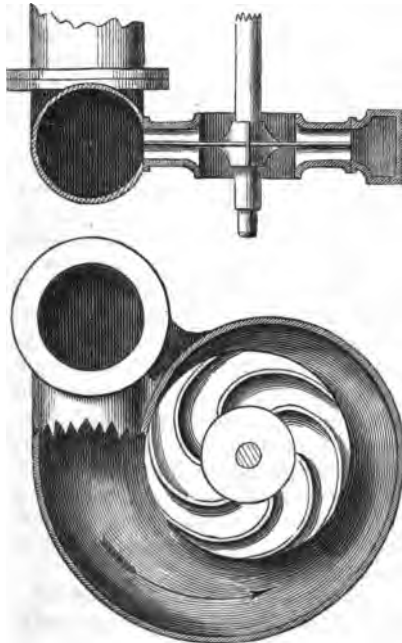

Plan.
VORTEX WHEEL.

The reciprocating water-pressure engine—a machine which has been too much neglected in England, will be treated of in a future chapter.

CHAPTER VIII.

UNDERSHOT WATER-WHEELS, THEIR USEFULNESS IN A NEW COUNTRY TO SAW TIMBER, ETC.

THE primitive form and use of vertical wheels for raising water for the irrigation of land in China and the East, has been already noticed. These, simply dipping their floats into a river, were turned by the current with such velocity and force as the stream might impart to them.

Yet, before quitting this part of the subject, it may be proper to mention two modes of applying these wheels which have been practised in America.

One of them was to place a strong axle across a boat, or some other vessel, of large dimensions, with a water-wheel at each end of this axle, like the paddle-wheels of a steam-boat; and this vessel being moored in a current, the wheels revolved, and gave motion to mill-stones, and machinery for grinding and dressing flour, on board the floating mill. The other was by means of a similar axle and a pair of wheels, thus mounted in a boat, to cause the boat so fitted to warp itself, and to tow other boats up a rapid, by winding one end of a rope round the axle, the other end being made fast to an anchor, or other mooring, above the rapid. This means of ascending rapids in the American rivers has been generally superseded by the employment of powerful steam-boats; but it is worthy of being recorded as an ingenious contrivance to derive from the resisting medium itself a power to overcome it, by duly proportioning the diameters of the wheels and axles.

The next improvement was an important one; and it rendered the vertical water-wheel a powerful mechanical agent.

By penning back the stream with a dam or barrier, thrown across its channel, so as to accumulate and raise the water to a head; and by cutting a canal, or water-course, in the bank, communicating with the reservoir so formed, and re-entering the river by its side at a lower level; by erecting the wheel in this water-course, and by interposing

a sluice between the wheel and the pent-up water, so as to stop or regulate its efflux, the whole power of the water, heretofore spread over the bed of the river, might be concentrated against the wheel, rushing through the opening of the sluice, with a velocity and impulse due to its head and volume, and acting upon the float-boards with an amount of force and effect which could not be obtained in the open river; the water being now confined between walls of solid masonry almost in contact with the wheel, and within which it revolved.

These walls also served to support the axis of the wheel, and to retain the sluice; while a pavement of heavy stones below, between the walls, prevented the water from escaping beneath the wheel until it had done its duty.

When the sluice was shut down and the wheel stood still, until the dam was filled to overflowing, the water passed over the barriers or weir, and rolled on, as before, through its old channel in the river, or was discharged into it through a waste-water sluice, sometimes made self-acting by means of a balanced float, or some similar contrivance; and, on adapting such apparatus, great ingenuity has often been displayed, especially in the Shaw's Water-works, already mentioned, as well as by some of the French engineers.

Arrangements like these, so simple, so effective, and so easily made and managed, rendered the UNDERSHOT-WHEEL most useful and valuable as a means of obtaining mechanical power sufficient to drive extensive flour-mills, fulling-mills, and forges, for which purposes it was, in the first instance, chiefly used, to aid an agricultural population in more readily supplying themselves with bread, woollen cloth, and iron—the principal requirements of a primitive community, with whom spinning and weaving were as yet domestic employments.

The sluice, which regulated or closed the opening through which the water issued against the wheel, was placed as low as possible, allowing only sufficient fall or space for the escape freely after it had passed the wheel, so that it might not, as a millwright would say, "be working in back water." The opening, or the sluice, corresponded in size, or nearly so, with the width of the float boards of the wheel, and the head of water above it caused the stream, or rather the jet, to strike the float-boards with a proportionate momentum, the wheel receiving, as it were, a succession of impulses as the float-boards continually entered the water.

Mr. John Smeaton, the most experienced and eminent engineer of his time, made a series of careful and elaborate experiments on the power and effect of water employed to turn mills, by means of undershot and overshot-wheels. Accounts of these experiments, with all their details and results, were submitted by him to the Royal Society and printed in their Transactions; the first of these papers, read before the Society on the 3rd and 10th of May, 1759, relates to undershot-wheels, and his definition of mechanical power and effect is so clear and concise, that it would be difficult to give a better explanation. He says:—

“The word *power*, as used in practical mechanics, I apprehend to signify the exertion of strength, gravitation, impulse or pressure, so as to produce motion: and by means of strength, gravitation, impulse or pressure, compounded with motion, to be capable of producing an *effect*: and that no effect is properly mechanical but what requires such a kind of power to produce it.”

“The raising of a weight, relative to the height to which it can be raised in a certain time, is the most proper measure of power, or, in other words, if the weight raised be multiplied by the height to which it can be raised in a given time, the product is the measure of the power raising it, and consequently all those powers are equal whose products, made by such multiplication, are equal; for if a power can raise twice the weight to the same height, or the same weight to twice the height, in the same time that another power can, the first power is double the second; and if a power can raise half the weight to double the height, or double the weight to half the height that another can, those two powers are equal.

“But *note* that all this is to be understood in case of slow or equable motion of the body raised; for in quick, accelerated, or retarded motions, the *vis inertiae* of the matter moved will make a variation.

“By the *vis inertiae* of bodies is meant the force required to put them in motion when they are in a state of rest, or to accelerate them suddenly; a corresponding force must be exerted to stop or check a heavy body when it is in motion.

“In comparing the effects produced by water-wheels with the powers producing them—or, in other words, to know what part of the original power is necessarily lost in the application, we must previously know how much of the power is spent in overcoming the friction of the machinery

and the resistance of the air; also what is the real velocity of the water at the instant that it strikes the wheel, and the real quantity of water expended in a given time.

“From the velocity of the water, at the instant that it strikes the wheel being given, the height of head productive of such velocity can be deduced, from acknowledged and experimented principles of hydrostatics; so that by multiplying the quantity or weight of water really expended in a given time by the height of a head so obtained, which must be considered as the height from which that weight of water had descended in that given time, we shall have a product equal to the original power of the water, and clear of all uncertainty that would arise from the friction of the water, in passing small apertures, and from all doubts, arising from the different measures of spouting waters, assigned by different authors. On the other hand, the sum of the weights raised by the action of this water, and of the weight required to overcome the friction and resistance of the machine, multiplied by the height to which the weight can be raised in the time given, the product will be equal to the effect of that power; and the proportion of the two products will be the proportion of the *power* to the *effect*: so that by loading the wheel with different weights successively, we shall be able to determine at what particular load and velocity of the wheel the effect is a maximum.”

The nearer the effect obtained approaches to the power expended in obtaining it, the better and more perfect is the machine. Let the student bear in mind that the *effect* can never be greater than the *cause*. This is too often forgotten, and much money has been spent and time wasted in contriving machines to perform impossibilities.

The principles of mechanics are now so generally well understood that perhaps no person into whose hands this book may fall, will ever dream of inventing a machine which shall give a result equal to the motive power and overcome its own friction; yet the time has not long gone by when ingenious persons, reasoning on false premises, vainly flattered themselves that they might accomplish such things and devise some machine which should continue in *perpetual motion* without a maintaining power.

Mr. Smeaton goes on to show how the velocity of the water striking the wheel may be practically ascertained: first, by running the wheel unloaded in the water, and

then by assisting it by means of counter-weights or cord wound round the axle, until the velocity of the wheel is identical with that of the water and the counter-weight, equal to friction and resistance of the air; for, if it were too little, the water would accelerate the wheel beyond the weight; and if too great, retard it; so that the water becomes a *regulator* of the wheel's motion, and the velocity of its circumference becomes a measure of the velocity of the water. The velocity thus determined, the virtual or effective head may be determined by the law of gravitation; and although, as Mr. Smeaton observed, the virtual head bears no certain or definite proportion to the actual head—as indeed has been shown in a foregoing part of this book—yet, when the aperture is greater, or the velocity of the water issuing therefrom is less, they approach nearer to a coincidence; and consequently, in large openings of mills and sluices, where great quantities of water are discharged from moderate heads, the actual head of water and the vertical head, determined from the velocity, will the more nearly agree, as experience confirms.

From the numerous experiments he had made on the undershot-wheel, Mr. Smeaton deduced the following rules, or, as he calls them, maxims:—

“1. That the virtual, or effective head, being the same, the effect will be nearly as the quantity of water expended.

“2. That the expense of water being the same, the effect will be nearly as the height of the virtual or effective head.

“3. That the quantity of water expended being the same, the effect is nearly as the square of its velocity.

“4. The aperture being the same, the effect will be nearly as the cube of the velocity of the water.”

Upon comparing the several proportions between *power* and *effect*, remarked during the course of his experiments, Mr. Smeaton observes, the most general is that of 10 to 3, the extremes 10 to 3·2 and 10 to 2·8; but as it appears, that where the quantity of water, or the velocity thereof, that is, where the power is greatest, the second term of the ratio is greatest also, we may therefore well allow the proportion subsisting in large works as 3 to 1.

He also observes, that the proportions of velocity between the water and the wheel are contained in the limits of 3 to 1 and 2 to 1; but as the greater velocities approach the limit

3 to 1, and the greater quantities of water to that of

2 to 1, the best general proportion will be that of 5 to 2. He endeavoured to ascertain what is the ratio between the load such a wheel would carry at the maximum of effect, and what will totally stop it, and found that it would work steadily until that proportion was as 4 to 3; but when this limit was exceeded, the whole worked irregularly, and was liable to be stopped.

The principal aim, however, of a good millwright, is to make the wheel work to the greatest advantage; and the last-mentioned experiments were therefore more curious than useful; yet they are highly interesting, as they make the investigation complete, and anticipate a question which might very naturally be asked.

Mr. Smeaton mentions, that in his working model of an undershot water-wheel, the maximum load was equal to 9lb. 6oz., and that the wheel ceased moving with 12lb. in the scale; to which, if the weight of the scale is added, nearly 10oz., the proportion will be nearly as 3 to 4, between the load at the maximum and that by which the wheel is stopped: and he says,—

“It is somewhat remarkable, that though the velocity of the wheel, in relation to the water, turns out greater than one-third of the velocity of the water, yet the impulse of the water, in the case of a maximum, is more than double of what is assigned by theory; that is, instead of four-ninths of the column, it is nearly equal to the whole column.”

It must be remembered, that in the present case the wheel is not placed in an open river, where the natural current, after it has communicated its impulse to the float, has room on all sides to escape; but in a conduit or race, to which the float-board being adapted, the water cannot otherwise escape than by moving along with the wheel; and when a wheel works in this manner, as soon as the water strikes the float it receives a sudden check, and rises up against the float, like a wave against a fixed object; so that in the working model, when the sheet of water was not a quarter of an inch thick before it met the float, yet this sheet acted against the whole surface of a float three inches high; and, consequently, if the float were no higher than the thickness of the sheet of water, a great part of the force would be lost by the water dashing over the float.

Although in this country the value of water power, and the necessity to make the most of it, has gradually caused the undershot wheel to be abandoned, and the breast wheel

to take its place, whereon the gravity or weight of the water acts instead of its impulse; yet there are many purposes to which the undershot wheel may be applied with

Fig. 26.

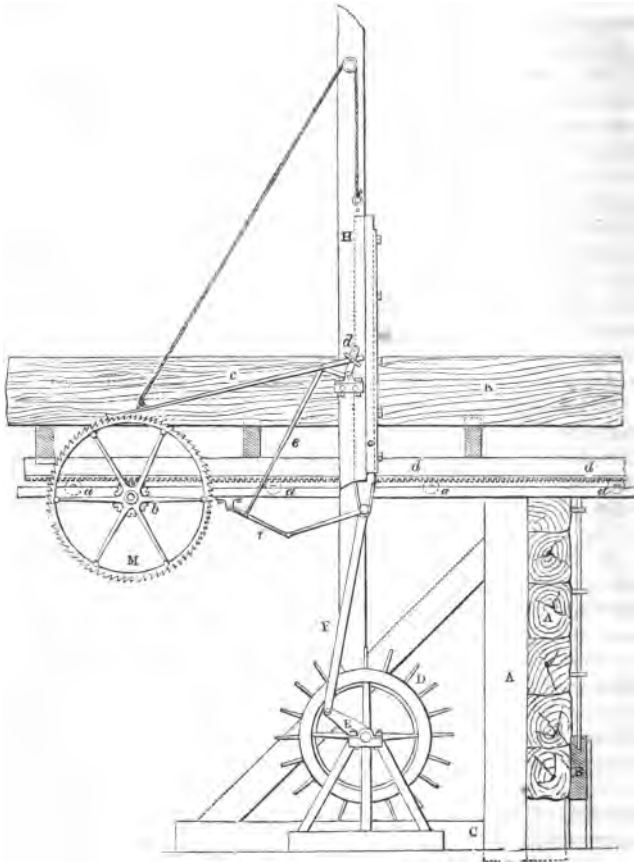

AMERICAN SAW MILL.

advantage, and to none more than the sawing of timber, especially in new settlements, and in those localities where water power is abundant and mechanical skill is scarce, where labour is expensive and timber costs nothing. In

such circumstances, a simple and efficient saw-mill is of great advantage, and it may be worked at once from the axle of the undershot water-wheel, working two saw frames, by means of cranked arms upon the ends of it; or, if the axle be made of iron, a crank may be formed in it to work a single saw frame, as shown in the annexed woodcut, reduced from an engraving in the Professional Papers of the Royal Engineers, vol. vi., in which will also be found a minute description, elaborately illustrated, of the saw mills and machinery for raising timber in Chatham dockyard, erected by the late Sir Mark Isambard Brunel. (See fig. 26.)

In this engraving *A* is the dam, frequently formed of square logs, resting against a standard secured by struts, provision being made to carry off the surplus water. *B* is the sluice, which, being raised to work the wheel, admits the water into the trough *C*; here it strikes the float-boards of the wheel *D*, which is generally made of small diameter, so that the velocity of the water may cause it to make as many revolutions as possible, consistent with the requisite power; the saws making as many strokes as the wheel makes revolutions. *E*, the crank on the wheel shaft, to which is adapted the connecting rod *F*, which is attached to the bottom of the saw-frame *G*. This slides up and down between the standards with an alternating motion, the strokes being double the length of the crank arm. *K* is the log to be cut; it is mounted on the frame *L*, which has a rack fixed in its under surface, and is supported by the rollers *a a*.

The pinion *b* on the axis of the wheel *M* works in the rack, and according as the wheel moves forward or backward, it works the frame, moving it towards or away from the saws. Motion is given to this wheel by the pall *c*, the other end of which is jointed to one of the sides of the arm of the bent lever *d*. This lever is moved backward and forward by the rod *e* which is jointed to the bent rod *f*; and this rod, or rather lever, is fitted upon an axle attached at one end to the frame of the wooden building and at the other to the frame of the saw-mill. When it is requisite to reverse the motion, after the log is cut, the pall *c* is lifted clear of teeth of the ratchet-wheel *M*; and this wheel is turned in an opposite direction by hand.

A saw-mill on this principle was made by the late Mr. Rennie, of which he has given the following brief

description: it appears to have been driven by the water of Leith. The diameter of the wheel was 4 feet 6 inches, and its width 3 feet 2 inches. The floats were 12 inches deep, and were inclined in direction 4 inches past the centre.

The cranks had 11 inches radius; there was one on each end of the water-wheel axle; consequently the saw-frames driven by them had 22 inches stroke. The one frame had five saws and the other frame two saws; they made 13.6 strokes to cut one inch forward.

The fall of water was 3 feet 7 inches, and it was conducted in a sloping direction, in such a manner as to be nearly a tangent to it; the perpendicular height of all being 3 feet 7 inches, and the horizontal distance 8 feet.

The sluice was 3 feet 2 inches wide, and was raised to the surface of the water, namely 18 inches, at the head of the slope where it was placed. The sluice being raised to the water's surface, the wheel made fifty-eight turns per minute, working the seven saws. The timber cut was Norway fir; in the frame with five saws it was $8\frac{1}{2}$ inches deep, and in the frame with two saws it was 6 inches deep, so that in one minute it cut 4.26 inches forward. It is to be observed, however, that in such small wheels there is a considerable loss of effect, when compared with wheels of larger diameter; and accordingly Mr. Rennie states the performance of another saw-mill, at Dartford, which, with the dimensions, he tabulates as follows:—

DARTFORD SAW MILL.

1. Water-wheel 16 feet diameter.
2. Breadth 4 feet 6 inches, depth 1 foot 3 inches.
3. Fall 2 feet 3 inches, head 2 feet 9 inches.
4. Spur-wheel, or inner end of shaft, 64 cogs.
5. Pinion on crank 18 cogs; thus the crank made 3.55 turns for one turn of the water-wheel.
6. Throw of crank 10 inches.
7. Slabbing-saw made $3\frac{1}{4}$ strokes for 4 inches advance of timber.
8. Deal-saw made 19 strokes to 1 inch advance.
9. Frame of saws 4 feet wide inside; saws 5 feet 3 inches long.
10. Ratchet-wheel 6 feet diameter.
11. Teeth of saws $\frac{1}{2}$ of an inch asunder.
12. Space taken out by saw $\frac{1}{2}$ of an inch.

EXPERIMENT.

1. Quantity of water, by floating wax balls, 2461 cubic feet per minute.

2. Quantity, by measuring at the tail of the wheel, 3297 cubic feet, medium 2879.

But as the water was gathering in the pool, and as the river was extremely dirty, it is likely that the principal error may be in first experiments; and therefore, instead of taking the medium quantity, we shall call it 3000 cubic feet.

Sixteen saws at work in two frames, namely, two slabbing and fourteen deal saws; the water-wheel made twelve turns per minute. Thirty-four saws being put on, the wheel made only eight turns per minute.

CALCULATIONS.

The diameter of water-wheel being 16 feet, its circumference is $3.1416 \times 16 = 50.2656$; this multiplied by twelve revolutions = 603.18 feet per minute, or 10.05 feet per second.

The head of water being 2 feet 9 inches, the velocity due from this is 13.3; thus the velocity of the head of water is to that of the wheel as 13.3 to 10.05, or as 5 to 3.778; hence the effect produced will be nearly equal to twelve horses.

The reader will notice that the saws in the present instance are driven, not from the axle of the water-wheel, but from a second motion. The wheel is of larger diameter, and makes a less number of revolutions; for the requisite speed could not have been obtained from so low a head of water, and it is therefore gained by driving the pinion upon the second shaft, which works the saws, by the toothed wheel of greater size upon the water-wheel axle. The speed given to this wheel is somewhat greater than Mr. Smeaton advises, but this is done to render it more readily applicable to the saws, and the fall from the wheel clears it of back water.

The public are much indebted to Mr. George Rennie for the very liberal manner in which he has given them these and other results of his father's experience, which will be found in the "Quarterly Papers on Engineering."

It is curious to remark, that the boards of the undershot wheel still bear the name of *floats*, although they are no longer turned by the current of the river. While the

cavities or receptacles for the water on the face of the overshot wheel are called buckets, although they bear no resemblance to a bucket, otherwise than by holding water. In these names we trace their origin from the ancient irrigating-wheel, turned by floats in the stream, and lifting the water in wooden buckets or earthen pitchers fastened upon the rim of the wheel.

A very simple and neat method of employing the impulsive force of water, when a small stream descends from a great height, is shown by a working model in the Museum of Practical Geology. A jet of water issuing from a pipe is made to strike the vanes of a small wheel, inclosed in case, and causes it to revolve rapidly. The wheel may be stopped, or its motion reversed, by turning a stop-cock or cylinder. The whole machine may be made of brass, or other metal, in a very compact form; and in a hilly country might be usefully employed at a farm in turning agricultural machines, to save manual labour. Its small size and cost make it well suited for such purposes (See woodcut). The model at the Museum in Jermyn-street is adapted to machinery for winding up ore from a mine.

Fig. 27.

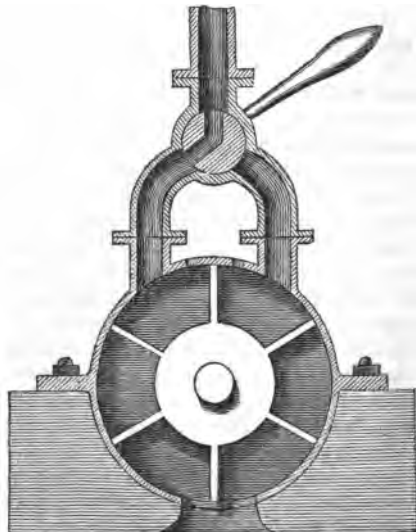

CHAPTER IX.

OVERSHOT WHEELS, GRAVITY OF WATER EMPLOYED INSTEAD OF IMPULSE.

It was not difficult to imagine that if a small stream of water descending from a hill side were directed into the mouths of the earthen vessels or wooden buckets of the wheels used for irrigation, the vessels so loaded would descend and the wheels revolve, so that rotary motion and mechanical power would be gained; the buckets emptying themselves at the lowest point, as they had before been emptied at the highest; the wheel turning in the opposite direction, because the weight, or gravity of the water was now the moving power of this OVERSHOT WHEEL.

In the undershot wheel the impulse of the water striking the floats drives the wheel; in the overshot wheel the weight of the water flowing into the buckets turns the wheel, and all impulse must be avoided; the water must flow with the same velocity as the wheel, or just so much in excess as will prevent the buckets from striking the water as they present themselves to be filled. Experience soon showed that the earthen jar or the suspended bucket were cumbrous and inconvenient, and as larger and more powerful wheels were applied to more copious streams, a series of simple wooden troughs formed across the face of the wheel were found to answer the purpose better. When the supply of water was ample and the wheel large, it was found that to fill these troughs well and regularly the stream should be made nearly as broad as the wheel, and shallow in proportion to its width. The wheel was then formed by placing two sets of *arms*, at a sufficient distance apart, upon the *axle*, and fixing to their ends *segments* of wood to form the circle; upon these segments across *the face* of the wheel, and equal to, or somewhat exceeding in length the width of the stream or sheet of water, were nailed the *sole-boards*; on the end of these boards, and at right angles to them, so as to form a projecting rim or ledge on each side of the wheel's face, was fixed the *shrouding*, formed of stout plank

generally from 12 to 18 inches broad; and between these shroudings, across the face of the wheel, were placed the *buckets*, made of lighter planking, and having their ends let into the shrouding, by which the ends were closed. The edge of the bucket-board meeting the sole-plank formed two sides of a triangular trough, the third being open to receive and discharge the water. Subsequently the bucket was made in two boards, one called the front, and the other the bottom of the bucket, the latter taking off the angle and making the section of the bucket, or form of the trough, that of a trapezium, which form it long retained, until the buckets-of-water wheels were made of iron plate.

Since water-wheels have been made wholly of iron, and chiefly of wrought iron, the form of the bucket has been either a part of a circle, a cycloid, an epicycloid, or an Archimedean spiral, and of these last-named forms especially in breast-wheels, which will hereafter be noticed. Great pains are now taken by the best makers of water-wheels to form and adapt the curve of the buckets so that they may readily fill with water, retain their load as long as possible, and discharge it with facility when it has ceased to be useful.

Mr. Smeaton's paper on undershot wheels, before quoted, was followed by another on overshot wheels, read before the Royal Society, May 24, 1759. These papers were long considered as the text from which millwrights should deduce their rules of practice, and even now they well deserve the careful study of those who engage in the construction of such machines, together with the later experiments of Rennie, Morin, and Poncelet.

Mr. Smeaton had the merit of proving and demonstrating the advantage and the difference of effect resulting from employing the weight instead of the impulse of a volume of water descending from a given height.

"In reasoning without experiment, one might be led to imagine that, however different the mode of application is, yet that wherever the same quantity of water descends through the same perpendicular space the natural effective power would be equal; supposing the machinery free from friction, equally calculated to receive the full effect of the power, and to make the most of it: for if we suppose the height of a column of water to be 30 inches and resting upon a base or aperture of one inch square, every cubic inch of water that departs therefrom will acquire the same

velocity or *momentum*, from the uniform pressure of 30 inches above it, that one cubic inch let fall from the top will acquire in falling down to the level of the aperture; one would therefore suppose that a cubic inch of water let fall through a space of 30 inches, and then impinging upon another body, would be capable of producing an equal effect by collision, as if the same cubic inch had descended through the same space with a slower motion, and produced its effects gradually: for in both cases gravity acts upon an equal quantity of matter, through an equal space; and consequently, that whatever was the ratio, between power and effect in undershot-wheels, the same would obtain in overshoot, and indeed in all others; yet, however conclusive this reasoning may seem, it appears, upon trial, that the effect of the gravity of descending bodies is very different from the effect of the stroke of such as are *non-elastic*, though generated by an equal mechanical power."

Gravity, it is true, acts for a longer space of time upon the body that descends slowly, than upon one that falls quickly: but this cannot occasion the difference in the effect; for an elastic body falling through the same space in the same time will, by collision upon another elastic body, rebound nearly to the height from which it fell: or, by communicating its motion, cause an equal one to ascend to the same height.

The observations and deductions which Mr. Smeaton made from his experiments were as follows—

First.—As concerning the ratio between the power and effect of Overshot-wheels.

"The effective power of water must be reckoned upon the whole descent; because it must be raised to that height, in order to be in a condition of producing the same effect a second time.

The ratio between the powers so estimated, and the effect at the maximum as deduced from the several sets of experiments, is shown to range from 10 to 7.6 to that of 10 to 5.2; that is, nearly from 4 to 3 and from 4 to 2. In these experiments, where the heads of water and quantities expended are least, the proportion is nearly as 4 to 3; but where the heads and quantities are greatest, it approaches nearer to that of 4 to 2, and by a medium of the whole the ratio is that of 3 to 2 nearly. We have seen before, in our observations upon the effects of undershot-wheels, that the general ratio of the power to the effect when greatest was

3 to 1; the effect, therefore, of overshot wheels, under the same circumstances of quantity and fall, is, at a medium, double to that of the undershot.

Second.—As to the proper height of the wheel in proportion to the whole descent:—

It has been observed, that the effect of the same quantity of water descending through the same space is double, when acting by its gravity upon an overshot-wheel, to what the same produces when acting by its impulse upon an undershot. Therefore the whole height at the fall should be made available, because, when the water is laid upon the top of the wheel, it is upon the gravity, and not the impulse, that the effect depends. A sufficient fall, however, must be given to lay on the water with a velocity *somewhat greater* than that of the circumference of the wheel, otherwise the wheel will not only be retarded by the buckets striking the water, but a part of it will be dashed over and lost, while the buckets will not be so well filled; but no greater velocity should be given than is sufficient to accomplish these objects, as it would be power wasted.

Third.—As to the best velocity of the wheel's circumference in order to produce the greatest effect:—

If a heavy body fall fairly from the surface of the head to the bottom of the descent, it will take a certain time in falling, but during the fall no mechanical effect is produced; for in this case the whole action of gravity is spent in giving the body a certain velocity; but if this body in falling be made to act upon something else, so as to produce a mechanical effect, the falling body will be retarded, because a part of the action of gravity is then spent in producing the effect, and the remainder only in giving motion to the falling body; and therefore the slower a body descends, the greater will be the action of gravity applicable to produce a mechanical effect.

If an overshot-wheel had no friction, or other resistance, the greatest velocity it could attain would be half a revolution in the same time that a heavy body laid upon the top of it would take to fall through its diameter, but no mechanical effect could be derived from the wheel.

It is an advantage in practice that the velocity of the wheel should not be diminished farther than what will procure some adequate benefit in point of power, because, as the motion becomes slower, the buckets must be made larger, and the wheel being loaded with water, the stress

upon every part of the work will be increased in proportion. Mr. Smeaton's experiments showed that the best effect was obtained when the velocity of the wheel's circumference was a little more than three feet, or a second; and hence, it

Fig. 23.

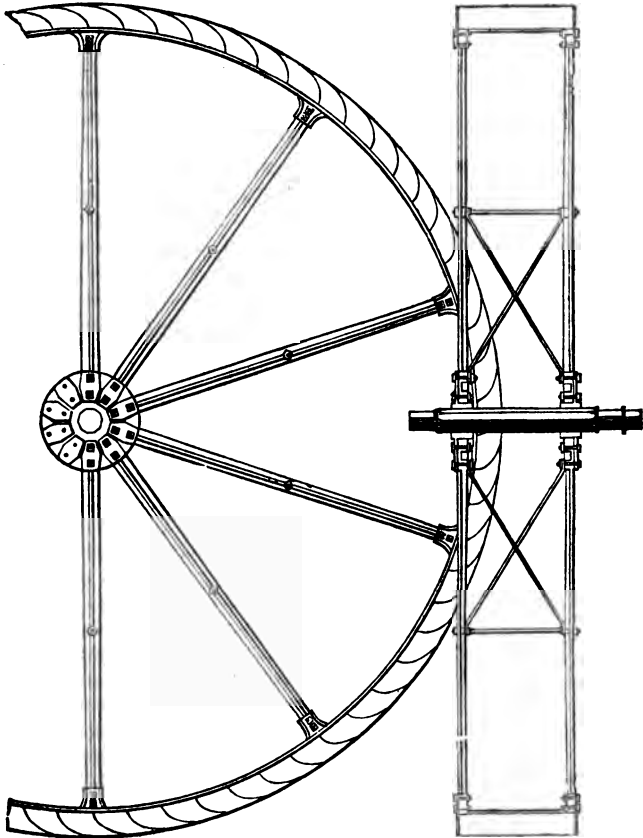

became a general rule to make the speed of the overshot water wheels at their circumference $3\frac{1}{2}$ feet per second, or 210 feet per minute.

Experience showed this velocity to be applicable to the

highest water-wheels as well as the lowest, and if all other parts of the work be properly adapted thereto, it will produce very nearly the greatest effect possible; but it has also been practically shown, that the velocity of high wheels may be increased beyond this rate without appreciable loss, as the height of the fall and the diameter of the wheel increase, and that a wheel of 24 feet high may move at the rate of 6 feet per second without any considerable loss of power.

The author has constructed several overshot water-wheels of iron 30 feet diameter and upwards; and for these he has adopted a speed of 6 feet per second with great advantage.

The circumference of a 30 feet wheel is 92.24 feet, and if it move at the rate of $3\frac{1}{2}$ feet per second, or 210 per minute, it makes only 2.275 revolutions, but if it go at the rate of 6 feet, it makes very nearly four revolutions per minute. The greater speed is advantageous, also, because it requires less gear-work to bring it up to the required rate for driving machinery; and because the load upon the water-wheel and its axle are reduced nearly in the inverse ratio of the speeds.

After making the requisite allowances, it will be found that a fall of 7 inches will bring the water upon the wheel with a speed of $3\frac{1}{2}$ feet full, and that a fall of $18\frac{3}{4}$ inches will give a velocity to the stream of full 6 feet per second; and, consequently, that the increase of speed and the reduction of load upon the wheel, as before stated, are gained at the expense of one foot of fall, making a difference of effect between a wheel of 31 feet diameter, at the slower speed, and a wheel of 30 feet diameter at the greater, in the ratio of 44.6 to 43.0; but the steadiness and regularity of motion derived from the momentum of the quicker wheel render this difference practically inappreciable as compared with the gain. By the foregoing comparison it will be seen how far the rule laid down by M. Smeaton may in practice be departed from as the diameter of the wheel increases.

The diameter, however, has its limits, and a water-wheel of great height is costly, cumbrous, and slow. A wheel was erected in South Wales by Messrs. Crawshay, at the Cyfarthfa Iron Works, near Merthyr Tydvil, 50 feet in diameter and 6 feet wide: it had 156 buckets, and made $2\frac{1}{2}$ revolutions per minute. This wheel, erected in the year 1800, was used to blow the furnaces. It was for some time the largest and most powerful water-wheel in use; but it has since been considerably surpassed. Mr. John

Taylor applied a fall of water in the mining district, near Tavistock, 526 feet in height, to give motion, to seventeen water-wheels; eight of them employed in pumping water from a depth of nearly 200 fathoms. The diameter of the largest of these wheels being 51 feet, with a width of 10 feet in the clear across the face; the smallest of the eight wheels being 32 feet in diameter, and the others of intermediate size. Four other wheels give motion to machinery for drawing up the ores to the surface; and the remaining five are employed to drive mills for crushing and stamping the ores.

The performance of the largest wheel was as follows: diameter, 51 feet; breadth, within the shrouding, 10 feet; the water poured into its buckets was at the rate of 5632 gallons per minute, which, at 10lb. per gallon, would be 56,320lb. weight descending 51 feet = 2,872,320lb. descending 1 foot. That is the power expended; which, being divided by 33,000 for a horse's power, according to Mr. Watt, gives 87.0 horse-power expended.

The wheel, when so supplied, made 5 revolutions per minute, and worked 6 pumps of the diameters and depths annexed. The length of stroke on all the pumps was 6 feet, and the effective stroke or motion in the pumps to raise water was at the rate of 30 feet per minute.

Lifts.	Fathoms	Feet.	Diameter.	Weight, lb.
1	43 ...	13 $\frac{1}{2}$	13 $\frac{1}{2}$ in.	16,136
3	112 ...	3 $\frac{1}{2}$	13 "	38,922
1	25 ...	3	14 "	10,225
1	6 ...	5	9 "	1,132
				66,415

The weight of the columns of water in all the six pumps amounting to 66,415 lb., being raised 30 feet per minute, is equal to 1,992,450 lb. per minute raised 1 foot; that is the power actually exerted in raising the water, which, being divided by 33,000, gives 60.36 horse-power realised.

The useful effect, or work done, being at the rate of 69.4 per cent. of the power expended, the remaining 30.6 per cent. being lost, partly by friction of the pump-work and resistance to the motion of the water through the pump, and by other retarding causes; this, however, is good duty for such a wheel so applied.

A wheel larger in diameter, but not so powerful, has been made by Messrs. Donkin & Co., of London, namely 76 $\frac{1}{2}$ feet

The width of face is 2 feet, the number of buckets 160, and the power stated to be 30 horses. It is all of iron, and principally of wrought iron. It was sent to Italy, where it has been erected and set to work, but the useful effect has not been ascertained.

Attempts have been made to employ a high fall of water by placing one wheel above another; this was tried many years ago at Aberdare, in South Wales, where two wheels, each 40 feet in diameter, were so placed, like the figure of 8, and were connected by teeth on their respective rims—the lower wheel receiving the water after it left the upper one, and revolving in the opposite or reverse way. The result was not satisfactory; but in another case, a drawing of which lies before the writer, wherein Messrs. Charles Wood and Brothers, of Macclesfield, had two overshot water-wheels each of 26 feet in diameter, and 6 feet wide, placed over each other, they succeeded by a somewhat different arrangement of the toothed-wheel works. The two wheels were not connected immediately with each other, but by means of *pinions*, which worked into teeth upon the rims of the two water-wheels, causing them both to revolve in the *same* direction, so that the water, on leaving the buckets of the upper wheel, was more easily and readily received by the buckets of the lower wheel.

In either of these cases, however, the employment of the turbine, or the *pressure engine*, which will be described hereafter, would have been much less costly and more effective. The like may be said of all the contrivances to substitute endless chains with buckets applied to high falls instead of water-wheels. When the waterfall is too high for a wheel to be used conveniently, the turbine or the pressure engine should be resorted to, according to the kind of work required to be done by the machinery.

Where the quantity of water is large and variable, and the fall such as may be termed an intermediate height, but varying also with the supply, it is found advantageous not to lay the water upon the top of the wheel, so that it may work overshot, but to make the diameter of the wheel greater than the mean height of the fall, and to lay the water, as it were, "*on the shoulder*" of the wheel, or at 45 degrees from the perpendicular, that is, half-way between the horizontal line and the perpendicular, or, as millwrights say, "at nine o'clock." Very little mechanical effect is produced in the upper eighth of the circle as compared with

the next quarter, on which the descent of the water is nearly perpendicular, and when the wheel is fitted with toothed segments at or near its circumference, acting on a pinion placed on a level with the axle, the weight of the water is brought to bear at once upon the pinion teeth, the stress is taken off the arms of the wheel, and the axle becomes, as it were, merely a pivot on which the wheel turns. By this arrangement, the late Messrs. Hughes and Wren, of Manchester, were enabled to make the arms of their wheels of simple tension rods of bar-iron, by which the rim of the wheel was tied and braced to the centre, a plan which, with some modifications and improvements, is still in use, and sometimes the segments have interior teeth, which renders the wheel-work more compact.

In the best constructed wheels, the water is laid on in a thin sheet of no greater depth than will give it a somewhat greater velocity than that of the wheel, the difference being just sufficient to pour into the succeeding buckets the proper supply of water. The buckets should be so capacious that they need not be full when the wheel carries its maximum load, in order that no water may be wasted, and that they may retain the water in them to the last moment that its weight on the wheel is effective, and yet empty themselves as soon as it ceases to be so. It is also expedient in practice to make the sheet of water not so broad as the wheels: if the wheel be broad on the face, the stream may be 2 inches at each end short of the length of the buckets: the air escaping at the ends then blows out no water with it; and all these precautions, though small in themselves, tend to produce smoothness, regularity, and increased effect in the working of the machinery.

There is, however, one mode of using water-power—acting by its gravity—in buckets upon a chain, much used in South Wales, which is found very useful for raising ore from the pits. An endless chain is passed over a wheel of 16 feet in diameter placed between two pits. The chain passing down each pit, and through an opening at the bottom between the two: two large buckets, or rather shallow tubs, of wrought iron, are fixed upon the chain, so that the suspension is by the centre of the tubs, and they are so placed that when one tub is at the top of its pit, the other is at the bottom of its pit. Each tub or bucket is covered by a strong platform, which fills and closes the pit's mouth when hoisted up, and carries the small wagon or tram containing the ore upon

it; and each is also fitted with a valve at bottom to discharge the water. A branched pipe, communicating with an elevated reservoir, is laid to the pits' mouths, and fitted with stop-cocks or valves. The tub at the pit's mouth being filled with water, over-balances the empty tub at bottom, and raises it, with its tram load of ore to the top. When the full bucket has descended the pit, the valve is opened and the water discharged; the other being filled in like manner, descends, and thus alternately each raises the other with its load of ore. The water finds its way out of the mine by a drift or adit into the valley; the long loop or bight of slack chain below the buckets, and hanging to the centre of each, equalises the weight of chain at all times; and a brake applied to the large wheel regulates the speed of the descending bucket. In some places, the two buckets work in one pit of an oblong form; the diameter of the wheel is reduced to 7 feet; it is fitted with toothed segments, working into a pinion, fixed upon a second axle, on which the brake-wheel is placed, in order to gain the requisite power to control the descending weight. Drawings of both these plans lie before the writer, but the principle and construction are so simple that description will probably suffice. It may be proper to mention that the buckets generally work in guides, that the discharging valves are opened by striking upon a point or projecting spike at the bottom of the pit, and that upon the platforms which cover the buckets there is a portion of the rail or tramway laid to match with the lines of way at the top and bottom of the pit, so that the tram or carriage may run from the platform to its destination.

CHAPTER X.

BREAST WHEELS, M. PONCELET'S WHEEL. LARGE STREAMS
AND LOW FALLS.

At the time when Mr. Smeaton wrote the papers on undershot and overshot water-wheels, before referred to, the BREAST-WHEEL was but little known, and imperfectly understood; for it seems then to have been a kind of compromise between the two, in which it was attempted to combine the action of impulse and gravity. It had become evident that the impulse of a column of water did not produce the same effect as its weight; and the experiments of Mr. Smeaton showed what the difference was. Having investigated the other two modes of applying water power, he contents himself with saying, "We might naturally proceed to examine the effect where the impulse and weight are combined, as in the several kinds of breast-wheels, &c.; but the application of the same principles on these mixed cases will be easy, and reduce what I have to say on this head into a narrow compass; for all kinds of wheels where the water cannot descend through a given space, unless the wheel moves therewith, are to be considered of the nature of an overshot wheel, according to the perpendicular height that the water descends from; and all those that receive the impulse or shock of the water, whether in a horizontal, perpendicular, or oblique direction, are to be considered as undershots; and, therefore, a wheel, which the water strikes, at a certain point below the surface of the head, and, after that, descends in the arch of a circle, pressing, by its gravity, upon the wheel; the effect of such a wheel will be equal to the effect of an undershot, whose head is equal to the difference of level between the surface of the water in the reservoir and the point where it strikes the wheel, added to that of an overshot, whose height is equal to the difference of level between the point where it strikes the wheel and the level of the tail water."

It is here supposed that the wheel receives the shock of the water at right angles to its radii, and that the velocity of its circumference is properly adapted to receive the

Fig. 29.

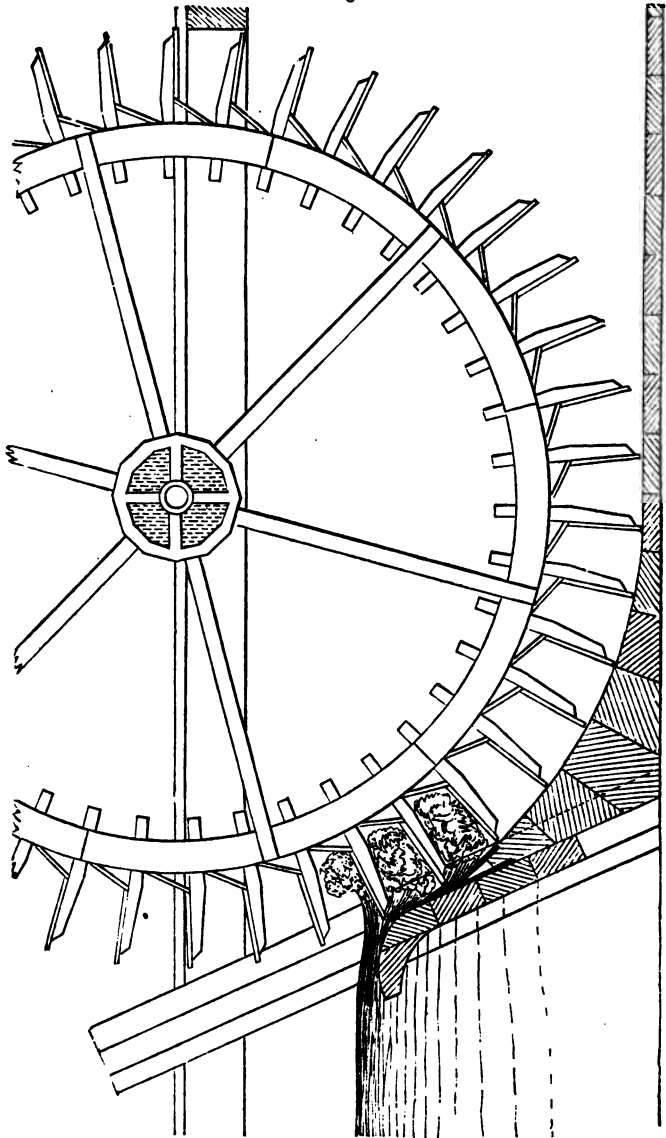

utmost advantage of both these powers; otherwise a reduction must be made on that account.

Here Mr. Smeaton leaves the subject; his remarks having suggested considerable improvements on the common practice of his day, and dispelled many popular errors. The principles he developed, and the rules he deduced from them, were productive of great practical benefit; and his papers may still be studied with much advantage.

The late Mr. Rennie may be said to have continued these researches; and, in 1784, he erected a large breast-wheel, worked by the weight of the water alone. To this wheel he first applied *the sliding hatch*, over which the water flowed upon the wheel, instead of issuing under the hatch or sluice, as formerly; and by this means the whole height of the fall is realised.

In this case, the sluice or hatch is to be drawn up, in order to stop the flow of water, which runs over it; whereas, before this time, it was let down to shut off the water running out below.

The water ran over the top of the sliding hatch, as over a dam, in a thin sheet, and was laid upon the *breast* of the wheel, or below the level of the axle, where it acted, by its gravity, upon the float boards; being held-up to the breast by masonry cut to a circular arc, drawn from the centre, fitting the wheels' circumference, and confining the water on all sides, so that none of it could escape without doing its part in the work; for the float-boards filled the channel, and there were sole-boards upon the rim of the wheel. Here let it be observed, that these sole-boards, which form an obtuse angle with the floats, are notched upon the oak starts to which the float-boards are fixed; but they do not completely close the wheel rim; a long narrow slit or opening is left across the face of the water-wheel, between the starts, permitting the air to escape, and the water freely to enter, as each bucket or float presents itself to receive its load; and should the river be flooded, and rise against the wheel, so that it "runs in backwater," the ready admission of air from above prevents a partial vacuum from being formed between the floats, which would tend to retard the escape of the water, and thus reduce the useful effects. Although in this wheel, which is without "shrouding" or sides, there is but little cavity or depth to cause such retention, yet in large wheels, with well-buckets and deep shrouding, the loss of power would be important. It has

always been the author's practice, even in over-shot wheels, to make provision for ventilating the buckets, and prevent "the suction," as workmen say, from the tail water. As, however, there is sometimes a little water lost by this means, and the orifice so left is more effectual when made larger, especially when buckets of much capacity are used instead of floats, as they now frequently are, in breast-wheels, an ingenious method of ventilating the buckets has been proposed by Mr. Fairbairn, which is well worth the little extra cost it may occasion in the first outlay of capital required for the erection of a large wheel.

Fig. 30.

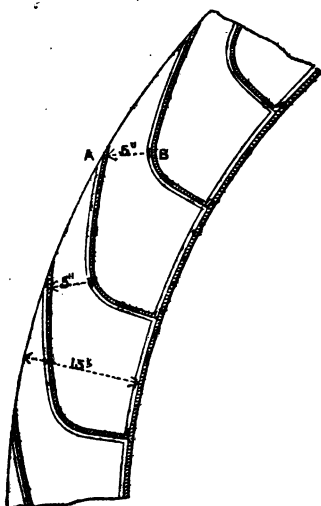

Proportions of Buckets.

Fig. 31.

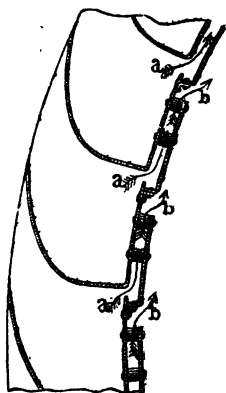

Ventilating Buckets.

In order to lay the water upon these wheels with the velocity required, and, at the same time, to keep the stream in a thin sheet, Mr. Rennie next adopted a double hatch, or sluice—adding, as it were, another hatch, fixed above the first; so that, by an adjustment of the two, a narrow opening might be left between them, capable of nice regulation to every variation of power required for the quantity of work to be done in the mill. The upper hatch dipped just so much below the water's surface as to give the

needful head above the orifice to produce a jet flowing with the desired speed; and the under hatch being raised or lowered by racks and pinions, the thickness of the stream delivered upon the wheel, was diminished or increased at

Fig. 32.

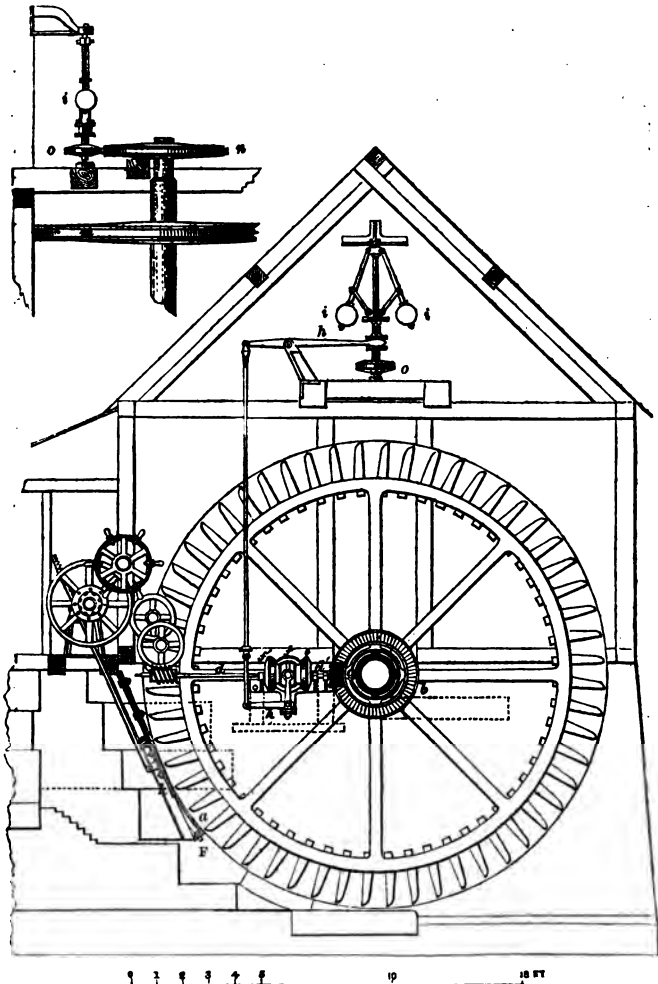

WATER-WHEEL AT WALTHAM ABBEY.

pleasure, while it continued to drive the mill at an uniform rate, by varying the load or quantity of water.

The next improvement was the application of the governor, or regulator, to adjust the supply of water to the wheel, without the attention of the miller; so that the slightest variation in the demand for power in the mill or factory might be met by a corresponding expenditure on the prime mover.

The double revolving pendulum, adopted, as a regulator for the steam-engine, by Mr. Watt, is generally used; and as the governor-balls fly out or collapse, the one or other of a pair of bevilled wheels is engaged and disengaged, so as to turn the pinion spindle, or endless screw, in opposite directions, and so moving the racks to raise or lower the sluice. Some of the French mechanics use a strong circular bellows, weighted on the upper boards and having a small opening for the escape of the air, so adjusted that when the wheel is working at the proper speed the upper board of the bellows is maintained at a certain level, but when the wheel goes a little too fast, the air accumulates in the bellows and raises the upper board, when a projecting iron finger fixed upon it "strikes into gear" one of the bevilled wheels, and disengages the other. The machinery so put in motion diminishes the supply of water, and the speed of the whole is reduced. On the contrary, when the water-wheel goes too slow, and the bellows are not fully inflated, the upper board sinks, and the iron finger reversing the motion of the pinion spindle opens the sluice, and increases the supply of water; but powerful bellows may act directly on the sluice itself. Sometimes when applied to overshot wheels, the governor moves a slide, with many long narrow openings in it, which coincide with similar openings in a metal plate in the bottom of the pentrough, or spout, which is closed at the end, so that the water must pass through these openings to the wheel; and, as they enlarge or contract with every movement of the vigilant governor, the speed of the wheel is kept uniform and steady. When the water is laid on the shoulder of the wheel, a curved slide, or a broad band of leather, rolled on or off a cylinder or roller, of small diameter, is substituted for a sluice. The leather is fastened at the lower end to a curved grating, adapted to the form of the wheel; and, at the other end, to the roller, which descends as the leather rolls upon it; and the water flows over the roller as it does over Mr. Rennie's hatch. Latterly

the curved slide, or sluice, the segment of a circle, fitting the periphery of the wheel, has been preferred to the leather band and roller, as being more durable; and the sluice is now better fitted, since improved tools have been introduced in the manufacture of machinery.

There are several other modes of applying governors; but these will, perhaps, be considered sufficient.

Breast-wheels are often made wide across the face, and of considerable power. One of the widest was erected many years ago, by Messrs. Strutt, at their Belper cotton-mills. It was 40 feet wide, but only 12 feet 6 inches diameter; the shaft was made hollow, like a cask, and so large as to form the body of the wheel, the float-boards being fixed immediately upon it. This hollow axis was 48 feet long, composed of thirty-two staves, 6 inches thick, bound together by iron hoops; the diameter in the middle was 7 feet 2 inches, tapering to 5 feet at one end, and 6 feet at the other, upon which a toothed wheel, 14 feet in diameter, was placed. The ends of this barrel were made solid for 3 feet at the small end, and 4 feet at the larger, to receive the gudgeons or pivots on which it turned. The float-boards, twenty-four in number, did not come in immediate contact with the barrel, but a space of 2 inches was left for the air to escape. The length of the float-board was divided into ten parts, and these were supported by rings fixed upon the hollow axis, placed 4 feet apart. The divisions of the float-boards were not placed in line with each other, but every one in advance of the next, by equal steps, so that the water might not strike the whole length of 40 feet at once, but act in a rapid succession of intervals, and thus make the stroke imperceptible.

A pair of very powerful wheels were erected about twenty-five years ago, at the Catrine Works in Ayrshire, by Messrs. Fairbairn and Lillie. It was originally intended to have four of these wheels, and provision was made for receiving them, should the factory be extended and require more power; but at present two wheels are sufficiently powerful, except in very dry seasons, to turn the whole work of the mills.

These wheels are each 50 feet in diameter; 10 feet 6 inches wide inside the buckets; and 15 inches deep in the shroud; they are fitted with internal toothed segments forming a circle of 48 feet 6 inches diameter; the teeth are $3\frac{1}{2}$ inches pitch, and the breadth is 15 inches. The fall of

water, conveyed from the River Ayr, is 48 feet, and the power of the two wheels 240 horses.

When iron is used to make water-wheels, as is now very generally the practice, curved buckets and shrouding are preferred to deal float-boards and oak starts.

In designing these iron wheels, care should be taken that, while attempting to form a bucket which shall carry the water as long as it can act beneficially, the openings or mouths of the buckets shall not be so contracted as to prevent the free admission of water into them, or its free discharge at the bottom of the wheel.

Mr. Fairbairn from his experience states that, in the construction of wheels for high falls, the best proportion of the opening of the bucket is proved to be nearly as 5 to 24; that is, the contents of the bucket being 24 cubic feet, the area of the opening, or entrance for the water, would be 5 square feet.

In breast-wheels, which receive the water at a height of ten to twelve degrees above the horizontal centre, the ratio should be nearly as 8 to 24, or as 1 to 3. With these proportions, the depth of the shrouding is assumed to be about three times the width of the opening, or three times the distance from the lip to the back of the bucket, the opening being 5 inches, and the depth of the shroud 15 inches.

These proportions are shown in *Figure 30*.

For lower falls, or those wheels which receive the water below the horizontal centre, a larger opening becomes necessary for the reception of a larger body of water, and its final discharge.

In the construction of water-wheels it is requisite, in order to obtain the maximum effect, to have the opening of the bucket sufficiently large to allow an easy entrance and an equally free escape for the water, as its retention in the bucket must evidently be injurious when carried beyond the vertical centre, or perpendicular line below the wheel's axis.

A new mode of applying the water to wheels worked by low falls has been introduced by M. Poncelet, whose works on hydraulics and especially on water-wheels are well known; his mode is fully elucidated in his "*Mémoire sur les Roues Hydrauliques à Aubes-Courbes, mues par-dessous.*" (Report on Water-wheels with Curved Buckets, worked below.) This distinguished engineer visited England during the Great Exhibition, and was appointed chairman of the jury on manufacturing machines and tools; he also acted as a

member of the jury on machinery, and gained the esteem of all who had the pleasure of meeting him in that capacity, for which his rank as General of Engineers in the French service, his acknowledged talent and practical knowledge, combined to make him peculiarly eligible.

M. Poncelet's method is especially well suited for falls under eight feet in height, and where the quantity of water is large, as by this mode of working the wheel from below, it is not subjected to a load of water, but receives it, as it were, under pressure. This wheel consequently can be made very light, although of great power, with arms of wrought-iron, like the paddle-wheels of a steam packet; and as it can be driven at a greater rate than the breast-wheel, a larger quantity of water may be brought to bear upon a narrower wheel. It is fitted with curved buckets, deeper than those of the breast-wheel, and without backs or sole-boards, so that within the rim of the wheel they are altogether open, and as the air can offer no impediment to the water's entrance or exit, the buckets are more numerous and their mouths narrower; one great object in this design being to make the action of the water continuous; avoiding the shock experienced in the undershot-wheel; the water enters them nearly at the lowest point of the wheel, and at a tangent to it, issuing from beneath a curved sluice, which is opened by being drawn upwards by racks and pinions. This sluice is nearly in contact with the wheel, so that the thin broad stream of water acts directly upon the buckets with all the pressure due to its head; and as they present themselves in rapid succession, this pressure is almost constant.

The sluice is placed in an inclined position, leaning as it were against the water, and is held down by radius bars extending from the back of it to the masonry below; these bars, being jointed at both ends, serve not only to retain the sluice in its proper place, but to guide it as it opens or shuts down upon the sill. The sluice is made of cast-iron, bolted together with flanged joints, planed to fit close, and form one large plate of equal breadth with the wheel, and at the sides it is kept tight by coming close to the stonework, or to cast-iron sides, against which a strong leather packing, secured to the sides of the sluice, is pressed by the force of the water.

The woodcut here given is taken from a drawing exhibited at the Institution of Civil Engineers, and represents a water-

Fig. 33.

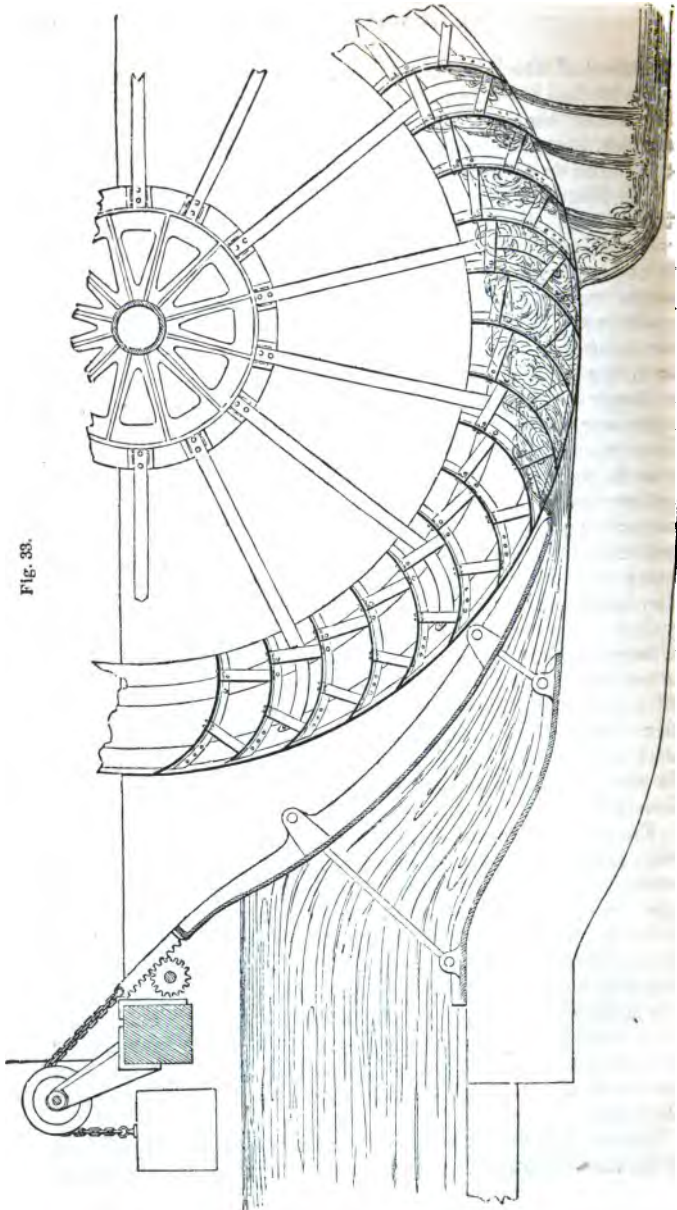

wheel on M. Poncelet's system, erected by M. De Bergue, who stated that this wheel, 16 feet 8 inches in diameter, and 30 feet wide; driven by a fall of water 6 feet 6 inches high, yielding 120,000 cubic feet per minute; was about 180 horse-power when the circumference moved at the rate of 11 to 12 feet per second: that a breast-wheel, worked by the gravity of the water in the usual way, and travelling at the ordinary rate, must have been 90 feet wide to produce the same effect; and that the speed of the wheel was about fifty-five per cent. of that of the water.

Referring to M. Poncelet's "Mémoires," before mentioned, in the second part, "Sur des Expériences en Grand," after having given the most elaborate details of his experiments, and tabulated them with all the method in which the French engineers excel, he says, under the head of *Calcul de la Vitesse et de la Force de la Roue*.—"With the various data which preceded, we shall be in a position completely to determine in a manner sufficiently exact for practice, all the dimensions of the wheel; to calculate its most advantageous velocity, the power it will transmit to the machinery when working at the maximum of effect, and the effect it is capable of exerting tangentially to its circumference.

"With respect to most advantageous speed of the wheel, it may be admitted, in accordance with the results of the experiments, that it remains compressed between 50 and 60 per cent. of the velocity due theoretically to the water level above the centre of the orifice, the last number having relation to low falls and large openings, the other to high falls and small openings of the sluice; so that for the medium falls of 1.3 mètres (about 4 feet 3 inches) above the sill of the aperture, with medium openings of 20 centimètres (7.87, say 8 inches,) the ratio of the speed will be nearly 55 per cent. As to the quantity of action transmitted integrally to the wheel, when it travels at this speed, it may also be admitted that the mean will be 60 per cent. of that which is due to the total fall, but that it will be somewhat less for the higher falls and smaller openings of sluices, and somewhat more for lower falls and larger openings."

This corresponds with Mr. Rennie's experiments, noticed in a former part of this book. The reader who wishes further to investigate this subject, would do well to obtain General Poncelet's work, *the new edition*, containing the "Second Mémoire" on experiments made on the large scale, which it is hoped may find a translator into the English language,

together with the researches of MM. Poncelet and Lesbros on the Flow of Water. Enough perhaps has been quoted in this little book to direct attention to those important works, which do honour to their authors and to the government which enabled them to make their experiments.

In a discussion which took place at the Institution of Civil Engineers, when M. De Bergue produced the drawing here engraved, the only point noticed as requiring improvement was the masonry below the wheel; it was thought that the platform of the race should stop somewhat short of the vertical line, so that the rising buckets might be emptied as soon as they passed it, and thus avoid the possibility of retardation from their retaining any water after it had ceased to be useful.

CHAPTER XI.

THE WATER PRESSURE-ENGINE AND THE WATER-RAM.

HAVING considered the means of obtaining mechanical power with a rotary motion, it is now proposed to describe another mode of employing the power of water in a manner essentially different, but not less useful and important, which has been too much neglected in this country. The advantages to be derived from the use of the WATER PRESSURE-ENGINE, in hilly districts, where high heads and an abundant supply of water are found, especially when mines exist in the same locality, and require to be drained in order to work out the ore, or when power is wanted to raise the ore from the mines, seem so obvious, that it is strange to think such ready and effectual help to the miner should be passed by; for the reciprocating motion of the pressure-engines may not only be applied directly to the pumps, but may also, by using cranks and fly-wheels like those of the steam-engine, be made to turn the winding machinery and the crushing mills, or any other revolving mechanism. Thus, by the pressure-engine and the turbine, the power of waterfalls of any height, however great, may at once be made available.

The first invention of the water pressure-engine, like

many other mechanical contrivances, appears to belong to Germany, and probably had its origin in Hungary, where so many ingenious machines, actuated by water, have long been used.

In the pressure-engine the power is obtained from a descending column of water acting by its weight or hydrostatic pressure upon the piston of a cylinder, in the same way that steam is employed; but as steam is an elastic fluid, and water (practically speaking) is not, care must be taken to prevent any sudden check to the motion of the water, which might break or damage the engine, and provision must be made to relieve the mechanism from any accidental shock so produced. In other respects, the action and the application of the water nearly resemble that of high-pressure steam.

The Germans appear to have made successive improvements upon their original engines, and to have extended, from time to time, their usefulness and employment, of which two important examples may be given.

The one is at Illsang, in Bavaria, at the salt-works, which are situated on the southern part of the kingdom. These works are supplied from a mine of rock-salt in the valley of Bergtesgaden, and from the salt-springs in Reichenhall, where the salt was formerly purified by solution and evaporation; but as this operation could not be carried on with advantage, on account of the scarcity of fuel, the saturated brine is now conveyed by a line of pipes seven inches in diameter, through which it is forced from stage to stage for a distance of about sixty miles by a series of nine pressure-engines, acted upon by falls of water from the hills and each of them working a pump.

A description of these engines will be found in the Proceedings of the Institution of Civil Engineers, and an excellent drawing, by Mr. W. L. Baker, of one of the best engines of the series, constructed by M. de Reichenbach, is in the collection of the Institution. This engine has a cylinder of twenty-six inches in diameter, with a stroke of four feet, making, in regular work, five strokes per minute; it is made entirely of brass, and is an exceedingly good machine both in design and workmanship. Very few working parts are visible, and it acts almost without noise, the sliding valves, or rather sliding pistons, which regulate the engine's action, being also moved by water pressure.

The other example, at Freyberg, in Saxony, is an engine

constructed, in the year 1824, by MM. Brendal, for draining the Alte Mördgrube mine. It has two single-acting cylinders attached to opposite ends of a working beam, by means of arched heads and chains; the cylinders are open at top, and have strong piston-rods of timber. The pressure of the water acts alternately under the piston of either cylinder, and forces it upwards, whilst the piston of the cylinder at the other end of the bearer is depressed by the weight of the pump-rods. A bell crank, attached to each piston-rod gives motion to the pump-rods, each working twenty-two pumps, placed one above the other, lying at an angle of forty-five degrees, and dividing the lift of each set of pumps into twenty-two heights or stages of about 30 feet. The engine is placed 360 feet under ground. The cylinders are of cast-iron, 18 inches in diameter, with a stroke of 9 feet, and the useful effect was computed by M. von Gerstner to be 70 per cent. of the power expended. A section of one of these cylinders has been sent to the author by a friend at Wiesbaden, and a very complete drawing of this engine by Mr. Baker will be found at the Institution of Civil Engineers.

The first water-pressure engine used in England was erected by Mr. William Westgarth, at a lead mine belonging to Sir Walter Blacket, in the county of Northumberland in the year 1765.

The cylinder of this engine was equal in length to the whole height of the fall of water; it was open at the top, and the water ran into the open top of the cylinder by a trough; the piston worked in a bored chamber, at the lower end of the cylinder, of 10 inches in diameter, and was attached by a chain to the arched head of an engine-beam placed above, the opposite end of the beam suspending a wooden rod, which passed down the pit to work the pump.

The column of water always pressed upon the top of the piston, but by admitting water below the piston, the pressure was neutralised, and the piston was raised by the weight of the descending pump-rods.

On closing the communication with the underside of the piston, and discharging the water from the cylinder bottom, the pressure of the column again acted upon the piston and sent it down. By a simple self-acting piece of mechanism, similar to the working-gear of the steam-engines of that time, the orifices were alternately opened and shut, and the reciprocating motion of the engine continued.

A detailed account, with drawings of this engine, was submitted to the Society of Arts, in the year 1769, and printed in the fifth volume of the Society's Transactions in 1787. The description and drawings were made by Mr. Smeaton, and a working-model then constructed from them is in the Society's possession. The Society voted fifty guineas to Mr. Westgarth, and presented a silver medal, with their thanks, to Mr. Smeaton, for his excellent account of so valuable an invention.

The author has carefully examined these interesting memorials of the early encouragement given the inventive genius by the Society of Arts, which continues with renewed energy its career of public usefulness, under the presidency of Prince Albert. He is satisfied, not only from the evidence which the machine itself offers, differing as it does entirely from any of the German engines, but from the written testimony of Mr. Smeaton, that Mr. Westgarth's Pressure-engine was his own invention; and that he borrowed no part of it, either in plan or in detail, from anything then or previously existing on the continent. His idea appears to have been taken from the single-acting open-topped atmospheric engine of the period; substituting the pressure of a column of water for the pressure of the atmosphere.

The liberality and goodness of heart which distinguished Mr. Smeaton, no less than his high talent and skill as a civil engineer, appear conspicuously in the correspondence alluded to, as will be seen in the following short extracts:—

Austhorpe, April 29, 1769.

“I had the pleasure of seeing the first complete engine of this kind at work in the summer of 1765, for draining or unwatering a lead mine belonging to Sir Walter Blacket, at Caldcleugh, in the county of Northumberland: since which, that machine has been shown to all those that had the curiosity to see it. Mr. Westgarth has now erected four others in the different mines of that neighbourhood, one of which I have seen, and all attended with equal success.”

In a subsequent letter, Mr. Smeaton says:—

“Mr. Westgarth was induced to think of applying for a patent for the exclusive privilege of using this invention, but previous thereto, he was pleased to advise with me,

concerning it, being frequently at that time in those parts of the country as an agent of Greenwich Hospital.

“Much as I admired the ingenuity of Mr. Westgarth’s invention, I dissuaded him from the thoughts of a patent, as it would take a length of time to be sufficiently known, and the number of cases in which it could be properly applied were not sufficient to afford such a number of premiums as might defray the expense of a patent, with a prospect of advantage to himself and family.

“I therefore recommended it to him, as the Society for the encouragement of Arts, Manufactures, and Commerce were, by handsome premiums and bounties, encouragers of all useful inventions and improvements, to communicate his invention to them, that it might be made public, in confidence that he would obtain a bounty for the same, of such value as to the Society should seem meet: and in consequence hereof, I gave him a representation of the utility of his invention, with which, in the year 1769, he applied to the said Society, and obtained a bounty upon condition he delivered to the Society a working-model and a draught showing the construction of the engine: but as the death of Mr. Westgarth, which happened not long after, prevented the usefulness of the machine from being so successfully spread, as it doubtless otherwise would have been; and as some of the most essential parts of the machine cannot be seen in the model, without taking it to pieces; and the drawing not being accompanied with any literal explanation, nor the details of it sufficiently made out; at the request of the Society, I have now supplied these defects, that it may be published in such a manner that the utility of it may be seen, and the means of making and applying it be explained.”

It appears that on seeing Mr. Westgarth’s engine, Mr. Smeaton suggested to him that if the engine, instead of the great lever or balance beam, were made to work with a wheel, and instead of the long spear going down the descending pump trees, the pistons were made to communicate with the main chain through a collar of leathers or stuffed collar, that then the whole of the machinery would stand together, just above the level or sough, and there would take up less room, as the work might in general be comprehended within the limits of the shaft; and the descending pipe might also be of a less bore, and be fixed in a corner of the shaft, and, therefore, be upon the whole,



much more convenient for underground works; and on this mode the latest engines of Mr. Westgarth were actually constructed with success. So that little was wanting except the perfection of modern workmanship, to render the engine complete, although it was not made direct-acting, as the engines recently made generally are.

Mr. Smeaton constructed a water-pressure engine, in 1770, at Temple Newsam, Yorkshire, to work a pump for supplying Lord Irwin's residence. It was, of course, of small size; and the pressure being communicated to the cylinder by an inclined pipe, bringing the water from some distance. He modified and improved the plan of Mr. Westgarth, closing the cylindrical tube, and using the piston-rod with a stuffed collar; still, however, retaining in its original form, or nearly so, the ingenious slide-valve designed by Mr. Westgarth.

This was a cylindrical hoop or ring, sliding, for a short distance, up and down a pipe which it encircled, the pipe having two sets of openings, separated by a horizontal bridge or partition. The valve was inclosed in a box attached to the branch pipe of the cylinder, and sustained the pressure of the columns equally in all directions; and it was rendered water-tight by strips of leather.

When the upper openings in the pipe were exposed above the water, the water entered the cylinder below the piston; but when the lower set of apertures was opened, by raising the cylindrical valve, the water escaped from the cylinder; the position of the valve at the same time shutting off the further entrance of the water and its pressure upon the piston. The openings were, in the first instance, square holes; but afterwards they were made in the form of a lozenge or rhombus, with the acute angle upwards, so that the water might enter and be shut off more gradually.

After Mr. Smeaton's time, the water-pressure engine seems to have remained in abeyance, and none were made until Mr. TrevithecK revived their use. The great improvements made in the steam-engine by Mr. Watt caused water-engines of all kinds to be neglected, and even water-wheels were, in many cases, superseded by steam-engines. Water power went out of fashion, and was generally considered to be too precarious and expensive, as compared with steam, to deserve much attention from engineers.

Lately, however, more enlarged views have been taken. Men who stand high in their profession have turned their

attention to this subject, and it has been more studied and better understood.

Mr. Trevitheck constructed several water-pressure engines,

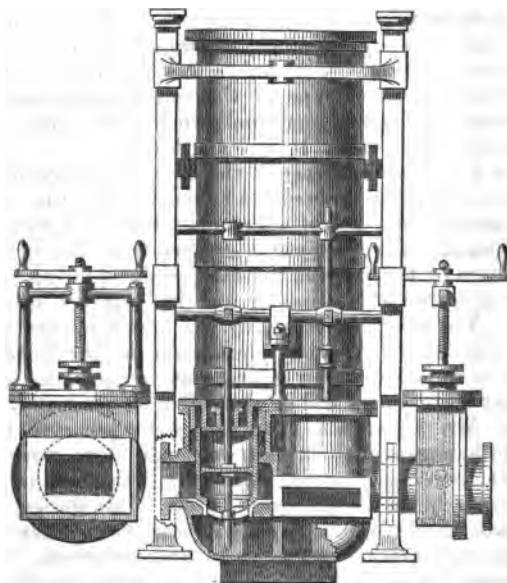
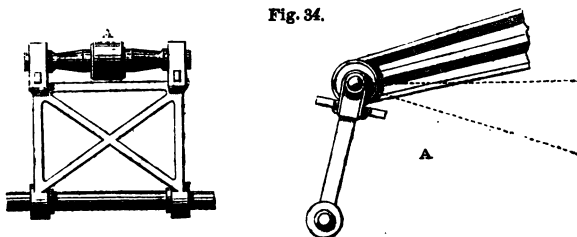

one of which was erected in Derbyshire, in 1803, and is still at work at the Alport mines. The cylinder of this engine is 30 inches in diameter.

Fig. 85.

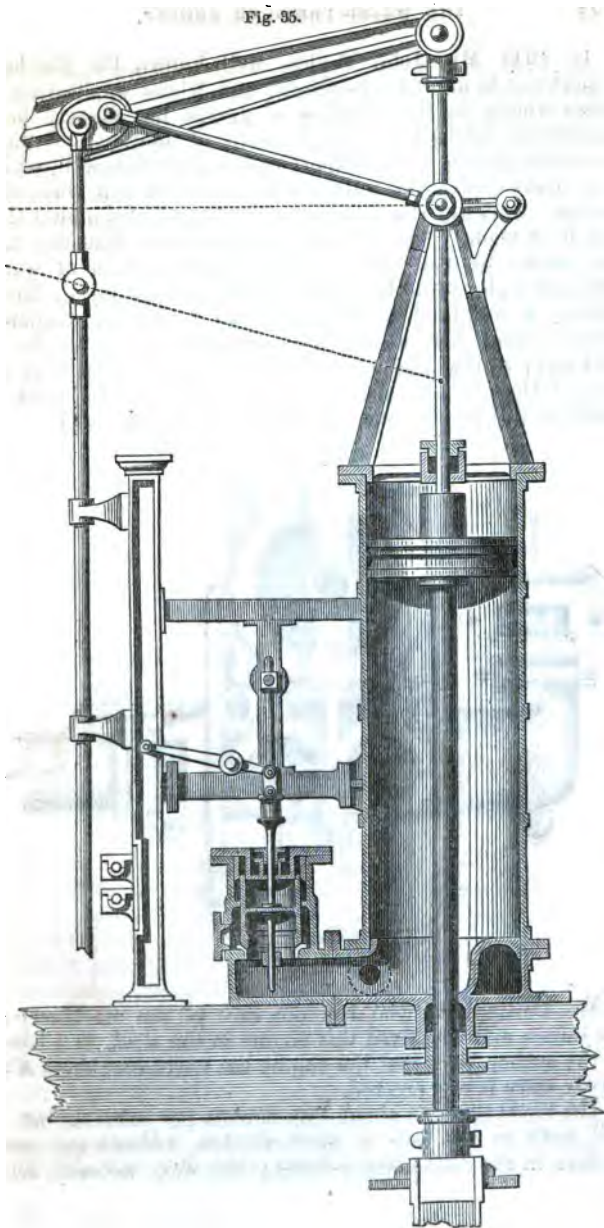

In 1841 Mr. John Taylor, well known for his long experience in mining operations, and whose application of water-wheels to the working of pumps has already been mentioned, advised the employment of another and more powerful engine at the Alport mines, near Bakewell, which was made under the author's direction, at the Butterley works. This was the most powerful engine of the kind that had been made. The cylinder is 50 inches in diameter, and the stroke 10 feet. It is worked by a column of water 132 feet high, acting below the piston, and lifting, by direct action, a weighted plunger-pole, 42 inches in diameter, which raises the water from the mine to a height of 132 feet; so that the proportion of power to effect is as the area of the piston to that of the plunger: namely, 1963 to 1385, or full 70 per cent. (See figs. 34, 35, and 36.)

Fig. 36.

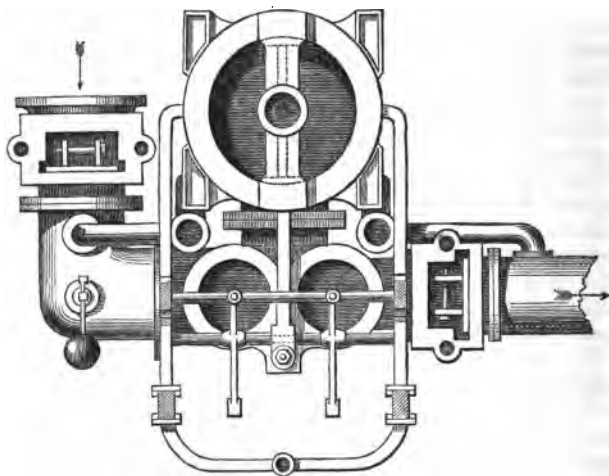

PLAN.

Mr. Darlington, who has the care of the machinery at the mines, and who fixed this engine in the shaft, in a letter to the author, says that the engine has never cost them £12 a year since it was erected.

The usual speed is about five strokes per minute, but it will work at the rate of seven strokes, without any concussion in the descending column; the duty actually done

being then equal to 168 horses' power of 33,000 pounds, raised one foot high in a minute. Thus the area of the plunger, 3 feet 6 inches in diameter, is 9·621 square feet \times 10 feet, the length of stroke, \times seven strokes per minute = 673·47 cubic feet raised 132 feet high in a minute; and 673·47 cubic feet of water \times 62·5 pounds, the weight per foot \times 132 feet in height = 5,556,127, which divided by 33,000, gives 168 $\frac{1}{2}$, say 168 horses' power. The pressure upon the piston from a column of water, 132 feet high, reckoning 27 inches of water equal to a pound, is about 58 pounds on the square inch, or rather more than 50 tons' pressure on the area of the piston. Thus the area of the piston, 50 inches in diameter, is 1963 square inches \times 58 pounds = 113,854; and this divided by 2240, the number of pounds in a ton, gives 50·8, say 50 tons.

There are five other pressure-engines at these mines of smaller size.

This engine was erected early in 1842, and is now working. It was at work, without intermission, for six years; and on one occasion, when the author made inquiry as to its performance, the answer was, that it had been constantly going for the last seventeen weeks, and nobody had seen it during the time.

An excellent working model of this engine will be found in the Museum of Practical Geology in Jermyn-street, London, an institution which ought to be visited by all persons who are interested in mining and metallurgy, and in the employment of mineral wealth for all purposes of practical utility and decorative ornament, as well as by geologists. The model was made by Mr. Jordan, since so well known by his invention for carving wood and stone by machinery, and thus copying works of art.

It will be observed that after the large valves are closed, the pressure is continued upon the piston to complete the stroke. This was at first done by means of cocks; but as the friction of these caused some little trouble, Mr. Darlington substituted some small pistons to shut off the water at the termination of the stroke.

Mr. Taylor has since had another engine of the same size made for a lead mine in Wales, and the results have been equally satisfactory.

In these machines, as in all others where the water acts by its gravity or pressure, the best results are obtained where the water enters them without shock or impulse, and

quits them without velocity. We then realise all the available power the water will yield, with the least loss of effect; and the duty is best performed by making the pipes and passages of sufficient and ample size to prevent acceleration of the hydrostatic column.

The cranes worked by water-pressure, constructed by Mr. William George Armstrong, of Newcastle-on-Tyne, have been described in another book, on *Cranes and Hoisting Machinery*, written by the author of this work.

These hydraulic cranes are characterised by their great steadiness and precision of movement. By means of the regulating handles, their motions, both in lifting and lowering, as well as in turning, are graduated with perfect accuracy; and, practically speaking, the speed with which they may be worked has no other limit than that imposed by the size of the supply pipe.

The author has the satisfaction to state that since the treatise on cranes was published, many of those worked by water-pressure have been erected, in and about London,—particularly in the collier basin of the West India Docks, where they are used to discharge the cargoes of the ships, and at the Great Western Railway goods station. They are also to be used at the Great Northern and the Camden Town goods stations.

Hydraulic pressure admits of very extensive and useful application in mercantile docks, not only to cranes for lifting heavy weights, but also for “whipping” light goods from ships, and for opening and shutting dock-gates, swing-bridges, and sluices.

The facility with which water may be conveyed to the places where the power is wanted, the ease with which it may be managed, its perfect safety, and its constant readiness for action, render it eminently suitable for these purposes.

When hydraulic engines are extensively used and systematically employed, it may be prudent to apply steam power to raise the water to an elevated tank, not less than 100 feet above their level, for that is in reality only another mode of using steam power, the water being the vehicle for its transmission. But there are many places where the supply may with advantage be obtained from the public water-works, and even when the water pressure may be used *in transitu*, without using the water. This is now actually done in Newcastle-on-Tyne, where an improved pressure-

engine, made by Mr. Armstrong, is used to print the *Newcastle Chronicle*, one of the most extensively circulated provincial newspapers. The author had the pleasure of seeing it in full work. The town is placed on the side of a high and steep hill, and the printing-office is about half-way up, so that the water merely passes through the engine and goes on to aid the supply for the lower parts of the town.

Fig. 37.

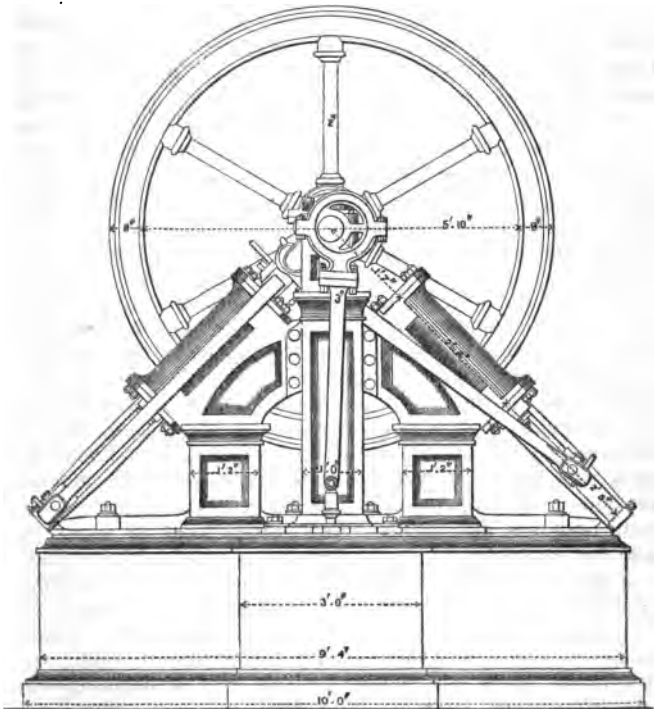

ELEVATION.

In many parts of London water is supplied, in quantity, at 4d. for 1000 gallons, at a pressure of 150 feet; and there are many trades that require occasionally to use mechanical power, but cannot employ a steam engine, for they do not want the power constantly, and they do not want much power at any time.

If the supply-pipe, conveying the water from the main into the workshop be of sufficient size, a small pressure-engine may at any time be set in motion, without risk of fire, and without requiring any skill in management, by the mere turning of a tap; and the turner, cutler, optician, or other artificer, may have auxiliary power whenever it suits him to use it,—the engine being also a perfect water meter, when a counter is attached to it, showing the number of revolutions it has made, and the quantity of water passing through it. A gallon of water weighs 10lb., so that 1000 gallons of water falling 150 feet are equal to 1,500,000 lb. falling one foot; and, if 1500 gallons of water be used in one hour, they are equal to 37,500 lb. falling one foot in a minute, or somewhat more than a horse's power, which is 33,000; therefore, allowing the difference for loss at the escape-valves, it may be assumed that the cost of a horse's power for one hour will be 6*d.* where the water runs to waste.

The engine which prints the *Newcastle Chronicle* has two cylinders, each $3\frac{1}{4}$ inches in diameter, or 8·9461 square inches area on their pistons; but the piston-rods are each one inch in diameter, and their area, $\cdot7854 \times 2$, must be deducted, leaving the area of the four sides of the pistons, less that of the rods, 34·2136 inches. The length of stroke is 7 inches, and the engine makes from 55 to 60 revolutions per minute, so that, taking the gallon of water to be 277·25 cubic inches, the total quantity of water used in one hour to work this engine is from 2850 to 3110, say 3000, gallons per hour. But in this case it is the pressure alone that is used, and not the water. The whole head of water is 430 feet, and of this column 200 feet are above the engine, and 230 feet below it. This difference of 200 feet, allowing 27 inches of head to give one pound pressure, is equal to 88 pounds on each square inch of the pistons. The stroke being 7 inches, a speed of 60 revolutions is equal to 420 inches, or 35 feet, per minute; so that, multiplying the area 34·2 inches \times 88 lb. \times 35 feet per minute, the product is 105,336 lb. falling one foot in a minute, which, being divided by 33,000, gives 3·19, or full three horses power.

Mr. Armstrong has made a water-pressure engine for an underground inclined plane in South Hetton Colliery. It has four cylinders, each only 3 inches in diameter, and 12 inches stroke. It usually works at about 100 revolutions per minute, and it is quite free from concussion at this high

speed. The column of water acting upon it is 600 feet, and the diameter of the supply-pipe is 4 inches. The engine is placed about 300 yards from the bottom of the shaft at the head of the inclined plane, 880 yards long, of an irregular acclivity, but in the steepest parts the rise is 1 in 18. Up this incline the engine hauls 20 loaded wagons, weighing collectively 15 tons. Each run is accomplished in six minutes, and the quantity of water expended in that time is 1500 gallons. This engine will eventually be required to draw 40 trains per day, in which case the quantity of water expended will be equivalent to a constant feeder of 42 gallons per minute. The greater part of the water used by this engine drains out from the upper part of the shaft, and before the engine was erected it was permitted to fall to the bottom, but it is now collected in a standage, which forms a reservoir for the supply of the engine; and when it is required to draw forty trains per day, the increase of pumping to be done by the great lifting engine which drains the mine will not exceed 20 gallons per minute during the twenty-four hours. The work done by this engine appears to be from 30 to 35 horse power.

Another engine, with four cylinders, is now in use for winding up ore, &c., from a lead-mine at Allenheads. The cylinders are 6 inches in diameter, with a stroke of 18 inches; the column of water acting upon it is about 230 feet in height, and the expended water escapes from the mine by a level: it commonly makes about 60 revolutions per minute, and then it raises a load varying from 7 to 10 cwt., exclusive of the unbalanced weight of the rope, at the rate of 900 feet per minute. The engine is provided with spur gear, for pumping, which can be thrown into action when the rope-drums are not in use.

Mr. Armstrong has taken a patent for improvements on the water-pressure engine, the principal of which consists in an ingeniously-contrived arrangement of escape or relief valves, to prevent concussion of the descending column at the turn of the piston's stroke. His usual plan is to fix the cylinders in an inclined position, like Sir Mark Brunel's *Thames Tunnel Engines*, at an angle of 90 degrees with each other, so that the two may act upon one crank.

The engravings show the general form; and the sections, kindly given to the author by Mr. Armstrong, show the mode of applying the relief-valves. (See Engravings.) By using three cylinders and dividing the circle by three cranks

Fig. 38.

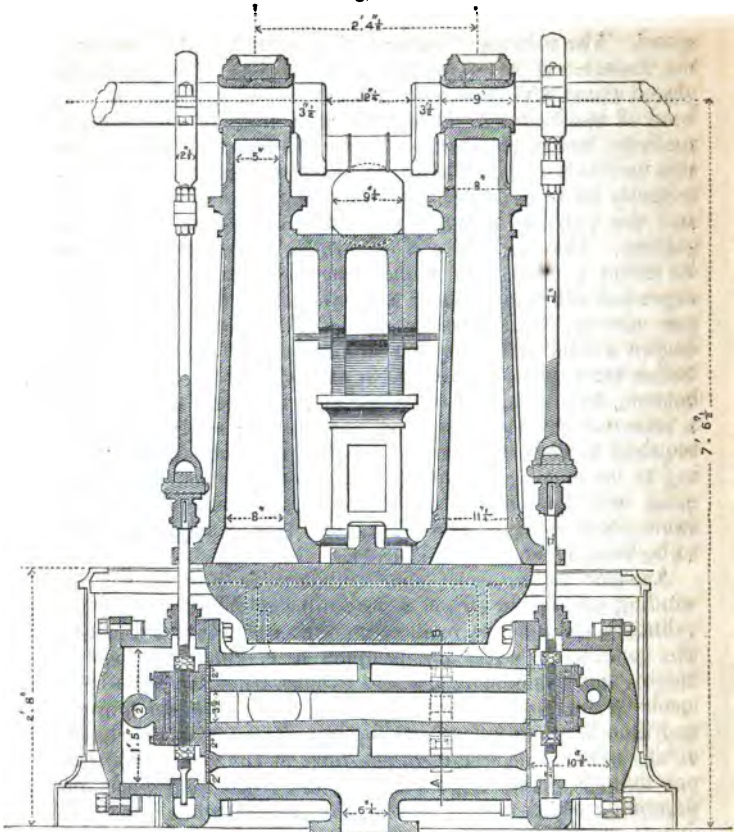

TRANSVERSE SECTION.

Side View of Slide Valves.

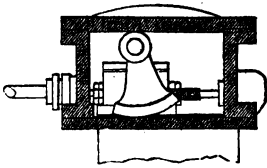

Section through A B.

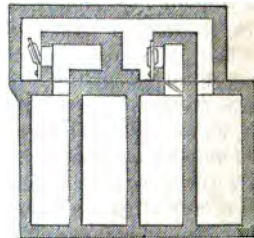

RELIEF VALVES.

into equal parts of 120 degrees, the motion would be rendered almost perfectly uniform, and the turn of stroke would be hardly perceptible.

There is another mode of applying the pressure of water as a motive power, which is exceedingly useful and convenient. The lift or hoist employed in cotton-mills and other manufactories, to convey persons from one floor to another, or from the bottom of the building to the top, without the fatigue of ascending the stairs, is generally known, and its utility well understood. By pulling a cord attached to the hoisting apparatus, it is immediately connected with the machinery of the mill, and the occupants of this *ascending-room* are carried up to any floor they please, together with such materials as they have occasion to take up; or by reversing the motion, are lowered to any story where they wish to land.

Such a lift would be a valuable addition to the convenience and comfort of many a lofty house in London, and save many a weary climbing from the basement to the upper rooms. Often has the wish been expressed, that some such contrivance might be adopted, but the want of motive power was a prohibition.

It occurred to Mr. Francis Wright, when he was building his mansion of Osmaston Manor, near Derby, that other arrangements for a lift might be made, and he found at the Butterley works the requisite mechanical skill to carry his ideas into practice.

At a convenient height above the manor was a reservoir of some extent, which was constantly replenished by means of a water-wheel in the park working a set of pumps, so that a supply of water at considerable pressure was always available.

A cylinder of cast-iron, about 46 feet long, was made in convenient lengths, and truly bored to an internal diameter of 11 inches: into this a piston was fitted and made water-tight by a leather collar, such as is used in the hydraulic press. The cylinder was sunk in the ground, and set accurately upright in the basement of the house, and the stem of the piston carried a platform or landing, with suitable railing and other appliances.

A pipe leading down from the reservoir, conveys the water into the cylinder, below the piston, which forces it up with the platform and the persons upon it, until the ascent is stopped by shutting off the water; then, by allowing the water to escape from the cylinder, the piston and platform

descend by their own weight until the escape of the water is prevented, or until the piston reaches the bottom of the cylinder.

The ascent required at Osmaston Manor is $43\frac{1}{2}$ feet; four persons are carried up in two minutes to the full height, and as the platform cannot rise or fall faster than the water enters or escapes, there is no risk from acceleration either way, because the size of the water-way determines the maximum speed of the piston, which is also regulated by the opening given to the valve.

The apparatus has been in action about four years, and has answered its purpose well. A similar machine, with a shorter lift, is used to raise the provisions from the kitchen to the level of the dining-room.

Assuming the elevation of the pond or reservoir to be 130 feet above the cylinder bottom (which is about the height), the pressure against the piston at the commencement of the lift will be about 58 lb. on the square inch, and when it has risen to the full height of $43\frac{1}{2}$ feet, the pressure will be about 43 lb. on the square inch, at the conclusion of the lift. The area of a piston 11 inches in diameter, being about 95 square inches, a pressure of 58 lb. gives a force of 48 cwt., and a pressure of 43 lb. gives a force of 36 cwt., which is found sufficient to overcome the friction, resistance, and weight of the machinery, and to raise the requisite loads, carrying up half-a-ton in about four minutes.

A like application of water-power may be advantageously made in many places, at wharfs, warehouses, railway stations, and docks, especially where hydraulic pressure is already provided to work the water-cranes, and where the weight of the platform and piston may be counterbalanced.

THE WATER-RAM.

In treating of water-pressure engines, it is remarked that care must be taken to prevent any sudden check being given to the descending column, and that relief or escape valves, air-vessels, weighted plungers, or some means of lessening the momentum of the water, are requisite to guard against the shocks which the machine must sustain if the motion of the water be impeded: this momentum, however, may be rendered exceedingly useful as a moving power, by which a portion of the water may be raised to a higher level by means of the *hydraulic ram*, to be used for manufacturing and domestic purposes, or for watering land above the level of the stream.

The water-ram, although it often figures in books on hydraulics, is less used than it ought to be: the reader generally regards it as a curious, old-fashioned device, and thinks no more of it; but for simplicity, cheapness, and useful effect combined, few machines are superior.

The merit of first employing the momentum of water to raise a portion of itself to a higher level is due to Mr. John Whitehurst, who, in a letter addressed to the Royal Society, in 1775, and printed in their Transactions, explains the principles of its action, and the mode of applying them, he had then successfully adopted.

M. Montgolfier, who does not appear to have known any anything of this communication, afterwards invented a similar machine in France, and gave it the name it still bears, "Le Béliér Hydraulique," from the butting action of the water; and Messrs. Boulton & Watt, with his permission, took a patent for it in England, dated December 13, 1797.

About twenty years later, the son of M. Montgolfier took an English patent for some improvements in his father's arrangements; and the visitors of the Great Exhibition of 1851 will remember two modifications of the hydraulic ram by London makers, Mr. Freeman Roe and Messrs. Easton & Amos.

The first machines made on the plan of the elder M. Montgolfier, by Messrs. Boulton & Watt, were exceedingly simple in their construction and arrangement, and yet very effective. A horizontal pipe, with a trumpet-shaped mouth to admit the water freely, was either inserted into the side of a supply-tank into which the stream flowed, and kept it full, or it passed through the dam into a reservoir that could be maintained at a uniform height. At the end of this pipe was a weighted valve, opening inwards, and upon the top of the pipe, near the end, was an air vessel, the capacity of it being at least equal to ten times the quantity of water to be raised at each stroke, and larger as the lift increased. At the bottom of the air-vessel was a valve, opening upwards, to admit the water into the air-vessel, and prevent its return, and to the air-vessel was attached the ascending-pipe, carrying up the water, raised to a higher level by the action of the machine.

The water being allowed to flow through the horizontal pipe, soon acquired velocity and force, and suddenly shut the valve at the end of the pipe; the momentum of the water, thus checked, lifted the valve in the air-vessel, forcing through

it a portion of the water, compressing the air within, and thus raising the water part way up the ascending pipe.

The force having been expended and the water brought to a state of rest, the weight-valve at the pipe end opened again; the descending column flowed through until its velocity again overcame the weight on the valve and forcibly shut it: thus, by repeated strokes, was the water raised to the top of the ascending pipe, and then every stroke discharged a volume of water inversely proportioned to the height.

The pipe conveying the descending water may be placed in an inclined position, instead of being laid horizontally; it is sometimes called the body of the ram, and the air-vessel and valves the head. M. Montgolfier considered, that with a well-constructed machine he might obtain 75 per cent. of useful effect; but the following were the results of experiment:

The fall of water was 3 feet 4 inches, the pipe, or body of the ram, 8 inches in diameter, and the height to which the water was raised, 15 feet 1 inch. The machine made 100 strokes in three minutes, expending in that time 67 cubic feet of water, and lifting $9\frac{1}{4}$ feet. Thus $67 \times 3.33 = 223.11$, and $9.25 \times 15.083 = 139.517$. Then $\frac{139.517}{223.11} = \frac{62}{100}$, or 62 per cent. of the power employed.

The improvements of the younger M. Montgolfier consisted chiefly of the introduction of a "snifting valve," admitting a small quantity of air to make up the loss caused by absorption from the air-vessel by the ascending water, and of a contrivance to retain a "cushion or mattress of air" about the seat of the stop-valve, in order to lessen the concussion. (See Section, Fig. 39.) The following table shows the results obtained by French engineers.

The first column shows the head or fall of water acting on the machine; the second, the quantity expended. The third shows the height to which the water was raised; and the fourth the quantity raised to that height. The fifth column shows the useful effect in each case.

Fall in feet.	Expended.	Elevation.	Raised.	Effects.
8.53	2.405	52.69 ft.	.2207	.565
27.30	5.951	195.02	.6189	.543
34.77	2.971	111.88	.6013	.651
3.21	70.282	14.92	9.5147	.629
22.96	.459	196.86	.0943	.640

The quantities of water expended and raised are reduced to cubic feet, and the mean of useful effect is $\cdot 605$, or say six-tenths of the power expended: experiments also show that it can do good duty where it raises water seven times the height of the fall. Practically, perhaps one-half of the power expended, or 50 per cent. of useful effect will be the amount realised; for it must be expected that in all these experiments, the machines were in good order; yet there are many localities where a water-ram may be used with great benefit, as it steadily and constantly performs its task with very little care on the part of its owner, except to see that the water is strained through a grating, to keep back extraneous substances, and that the apparatus is protected or emptied during a hard frost. The first example mentioned raised $9\frac{1}{2}$ cubic feet, or 57·8 gallons in three minutes, amounting to 27,750 gallons in twenty-four hours, to a height of 11 feet 9 inches above the pond that supplied the water; and this without labour or expense, beyond the interest of its cost.

It is true that the heavy blow or shock, given by the momentum of the descending column, has hitherto limited the size of this apparatus; but this shock may be lessened by increasing the number and improving the form of valves and pipes; and the principle may probably be still further developed in the hands of skilful mechanics, as it has been successfully done in the pressure-engine.

After the foregoing passages had been written, the author was favoured with a letter and drawing from Messrs. Easton & Amos, of Great Guildford-street, Southwark, who exhibited one of their machines at the Crystal Palace; the drawing showing their mode of fixing it, to supply water to a mansion in the country.

They have made some improvements, for which they have taken a patent; and they state they can obtain a mechanical effect of 65 or 70 per cent.; that the lowest available fall is 2 feet, and the highest 35 to 40 feet; the quantity of water they lift varies with the size of the ram and height of the lift from half a gallon to 6 gallons per minute.

The greatest height to which they have raised the water, by a machine which has been at work some years, is 330 feet. They lay the "*injection pipe*," or body of the ram, at an inclination varying from one in eighteen for small falls to one in four for high falls. Having formed a dam across the stream, they take the water by an earthenware conduit-pipe

Fig. 39

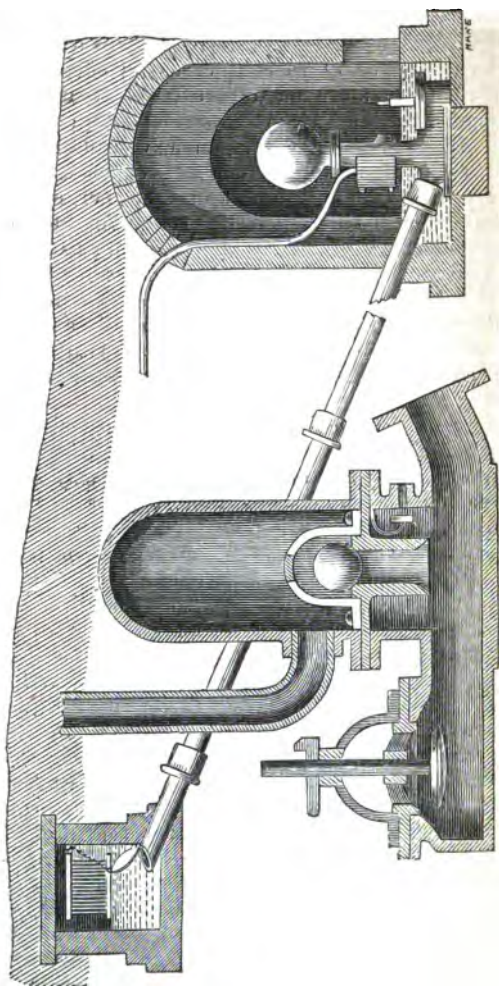

into a covered tank of brick-work ; this receives the mouth of the inclined cast-iron pipe, which is opened or closed at pleasure by a flap valve ; the pipe is laid in the ground below the reach of the frost, and the apparatus is fixed in a circular and domed vault of brick-work, which protects it from freezing ; and from which the water that works the ram is conveyed by a covered channel to some convenient point where it may rejoin the stream at a lower level. The ram is secured to a stout piece of oak or elm timber built into the brick-work. (Fig. 39.)

To enable them to make a correct estimate of the size, capability, and cost of these machines, they require to know,—

1st. The number of feet fall to be obtained at the spring or brook to work the ram.

2nd. The perpendicular height from the lower part of the fall to the point where the water must be delivered.

3rd. The horizontal distance from the place of supply to the place where the water is wanted ; and if the spring or stream be small, it is desirable to ascertain how many gallons it flows per minute.

CHAPTER XII.

THE APPLICATION OF WATER POWER TO GRIND CORN.—THE PROGRESS OF CORN-MILLS, AND DEVELOPMENT OF THEIR MACHINERY.

In applying water power to grind corn, the usual mode of computing the mill's capability is to ascertain the height and volume of the fall, and thence the available force, expressed in horses' power ; and the wheel is so proportioned that when driven at the rate determined, the buckets may be about two-thirds filled by the average supply of water ; in order to avoid waste at ordinary times, and also that during the excess in floods, an additional load in the buckets may compensate for the resistance of tail water.

It has been shown in the preceding pages that 12 cubic feet of water per second, or 750 pounds weight, are equal to an available horse's power, for each foot in height of their fall when acting by gravity on a well-constructed water wheel ; that is to say, the useful mechanical effect is 73 per

cent. Mr. Rennie in some cases obtained 80 per cent. ; and few wheels and mills, executed with ordinary care and skill, realise less than two-thirds, or 66 per cent. of the water-fall's power.

As the force required to drive machinery of all kinds is now generally expressed in horses' power, except it be immediately applied to work pumps, it has not of late been thought necessary to make direct experiments to show the weight of water required to drive modern mills ; their owners are satisfied to know, or to assume, that they do their work with a given number of horses' power of the usual standard ; namely, 33,000 pounds raised one foot high in a minute.

Consequently there are few recorded trials worth notice, since those of Mr. Thomas Fenwick, who found that 300 pounds of water falling 210 feet in a minute, would grind one boll (or two bushels) of corn in an hour.—He says—“The quantity of water expended on the wheel was measured with great exactness ; the corn used was in a medium state of dryness ; the mills in all their parts were in a medium working state, the mill-stones, making from 90 to 100 revolutions per minute, were from $4\frac{1}{2}$ to 5 feet in diameter.”

Therefore it took $\frac{300 \times 210}{2} = 31,500$, or very nearly a

horse's power to grind a bushel of corn.

To ascertain the friction of a mill when going with velocity sufficient to grind two bolls of corn (or four bushels) per hour, he made a series of experiments in the following manner :—“The mill was made quite clear of corn, and the upper mill-stone raised, so that it would touch as little as possible on the under stone, in its revolutions, then such a quantity of water was admitted to flow on the water wheel, (an overshot wheel) as to give the mill, when empty, the same velocity it had when grinding corn at the rate of two bolls per hour, which quantity of water was sufficient to raise a load of 300 pounds with a velocity of 100 feet per minute.”

This he therefore considered as the measure of the friction, and concluded, that as the power requisite to grind two bolls of corn per hour, including the friction of the mill, was equal to that which can raise a weight of 300 pounds with a velocity of 350 feet per minute, the difference of the two which is 300 pounds raised with the velocity of 250 feet per minute, is equal to the power

employed in the actual grinding of the corn. This gives a proportion of $\cdot 714$ to 1, or somewhat over 71 per cent. of useful effect.

Mr. Fenwick, who was of an ancient family in Northumberland, was by profession a "colliery viewer;" he had a high reputation for mechanical and engineering skill, and was living in the schooldays of the author; he wrote several works on practical mechanics and mining, which were at that time esteemed as good authority and went through several editions.

He does not state what kind of mill-stones were employed, but probably they were the "Dutch blue stones" then in use, a kind of lava rock, wrought chiefly in the German quarries near Andernach and Coblenz, brought down the Rhine and shipped to this country from Holland. They had superseded the mill-stone grit or "grey stones" as they also have since been displaced by the "French burr stones," now generally employed in grinding wheat. The blue stones are but little used, and the grey stones are seldom seen,

Fig. 40.

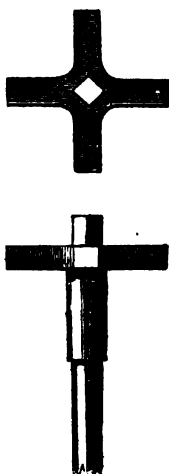

The fixed cross or rynd.

Fig. 41.

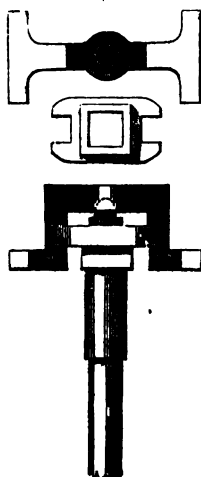

The bridge rynd.

except in the north for grinding oatmeal, rye, or barley-meal. These blue stones were each in one piece, and were

then dressed slightly conical on the face, the lower millstone being convex about three quarters of an inch, and the upper stone about an inch concave. The upper end of the spindle was square, and upon it was fixed a wrought-iron cross or rynd, which was let into the upper millstone, so that great exactness was requisite to make the stone true to the spindle. (See Fig. 40.) Afterwards a pivot or centre-point, tipped with steel, was formed on the top of the spindle above the square, and projected up into the eye of the upper stone for about half its thickness; a bridge of iron was let into the stone and rested upon the point of the spindle, a cavity being formed to receive it, and the upper stone was balanced upon the spindle point, at or about its centre of gravity; a driver was fitted on the square with two claws at each end loosely clipping the bridge; the stone vibrated freely like a compass card, resting on the bridged rynd and turned by the driver, so that when the stone was set in rapid motion the centrifugal force caused it to revolve in a level plane, and neutralised any little inequality in the balancing. (See Fig. 41.)

Then it was found better to dress the stones to a level face instead of making them conical, and the upper stone, thus balanced, spun round and seemed to float as it were, almost in contact with the nether stone, but not touching it.

The French burr stone is a sharp porous siliceous or chert, found chiefly on the banks of the Marne, the quarries extending up to Epernay, whence it is brought in bateaux and carried down the Seine for shipment at Rouen or Havre; it resembles bread or rather paste in state of fermentation, changed into stone, and is found so much more effective for grinding corn, that a small surface and consequently a less millstone, answers the purpose. The blue stones were often six feet or more in diameter, and seldom less than five, four and a half feet being considered a small stone. The French stones seldom exceed four and a half feet, or four feet in diameter; consequently they run faster and produce flour of better colour and quality, as they do not retain the corn so long between them nor rub down the bran with the flour.

From the peculiar formation of the French burr, it is difficult to get a whole stone of uniform quality throughout, and therefore it has been found expedient to build the millstone of selected pieces cemented together with plaster of Paris, and hooped with iron; the stone is then finished

smooth with cement on the back, and dressed to a true and level face, the work or races are cut in, which cross each other when the millstones are in action (see fig. 42). and the face of the stone having been proved with a paint or trying staff, a strong ruler of hard wood, the stone is sharpened by dressing it all over the face with a broad steel chisel or bill, hatching the stone in parallel lines about an eighth of an inch apart, and in some mills much closer, like the teeth of a file.

Fig. 42.

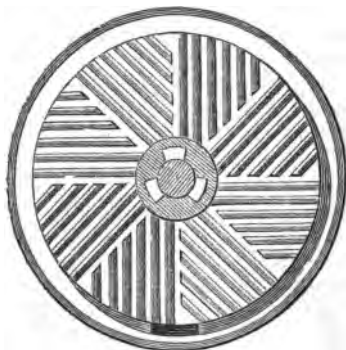

THE NETHER MILLSTONE.

To dress or sharpen the millstones with the chisel or bill requires great precision of eye and hand, and much practice to do this well, when the work is close and fine. Those who took an interest in the mill machiner of France in the Great Exhibition, generally found an opportunity to examine and many to make trial of a very ingenious tool, or rather a piece of mechanism, somewhat like a ruling machine or dividing engine combined with the mill chisel, to guide the hand of the miller when he dresses the millstones, and enabling him to put in the work, however minute, in parallel lines of equal width. The shaft which holds the chisel works upon a pivot like a small forge hammer, and on this pivot is a screw by which the divisions or spaces between the cuts are determined at pleasure, and the bearings of this pivot which is about 15 inches long are $7\frac{1}{2}$ inches apart; these slide on two guide bars and keep the cuts parallel; there is a rest for the arm of the miller, who keeps the chisel going, making the usual sharp cracking noise, but doing his work

much more rapidly and regularly with the help of this implement than he could before, besides which, it renders any miller of ordinary skill capable of doing first-rate work.

Lately another mode of hanging the millstones, instead of the bridge or centre rynd, has been introduced: a pair of "*gymbal rings*" in a compact form are fitted to the spindle-head, and the stone is suspended in the same way as the sea compass, so that it vibrates equally on all sides with-

out being checked, even by the driver, and as it can be nearly balanced in this way it swings round very steadily when in full work.

A further improvement has been attempted, and in several instances successfully, of making the upper millstones with hollow backs and blowing into them a current of air by means of a fan blast. Several examples of this kind, both English and foreign, were to be seen in the Great Exhibition, with holes or openings made through the stone in various ways, so that the air may pass between the millstones when grinding, and being thrown out at the circumference or skirt of the stone it expedites the grinding and keeps the flour cool.

While so many inventions have been applied to the upper

millstone, the lower stone has not been neglected; long after the author was acquainted with mill work, the nether millstone rested on a framing of wood, and the only means of making the face of it perfectly level or at right angles to the axis of the spindle, was by wooden wedges and packing—a tedious and difficult operation. This was obviated by a cast-iron seat with the means of adjustment by set screws, and latterly a wrought-iron cradle of an equilateral triangular form receives the nether millstone. The angles being equal, and a screw being placed at each angle, the millstone rests on three equidistant points, and is in this way as easily set as a spirit-level. This seems a

Fig. 43.

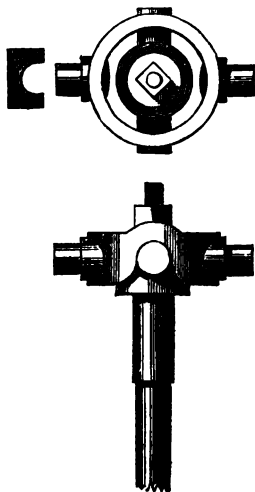

GYMBAL RINGS.

favourite plan with the Americans and the French millwrights, but although the three points must bear equally, many of the English mechanics prefer adjustment by four points, by which they obtain two level lines intersecting each other.

The stone being truly levelled on the face, is now often adjusted and fixed horizontally also by three or four screws dividing the circumference; but in many mills it is retained by a strong curb of wood surrounding the stone, and rising up within an inch or two of its face. This curb serves also as a base for the wooden case inclosing the millstone, and through it the meal is discharged by the spout below into sacks or binns as may be most convenient. In several of the modern mills the case is made of sheet-iron, sometimes zinked or galvanized, and the meal descending by the spout falls into a long trough fitted with an endless screw of a coarse pitch and deep thread, sometimes of cast iron, sometimes of thin plate of equal length with the trough, revolving in it, which conveys the meal to some convenient point, whence it is carried up into a higher loft by means of an endless belt or web fitted with light iron or tin buckets, and called by the millers a "Jacob's ladder;" here it is distributed as may be desired to be ready for the dressing-machine.

The most conspicuous adjuncts of the millstones were the hopper with the feeding trunk or shoot, to bring the corn into the hopper from the floor above; the shoe to carry it over the eye of the millstone; the mill clack or "damsel," to shake the shoe and supply the corn evenly and regularly from the hopper to the mill; the cord and peg to raise or lower the point of the shoe and augment the feed; the wooden spring to make the shoe recoil; and the warning bell, to call the negligent miller to his empty hopper. Pleasant it was to see all this simple, but ingenious apparatus, steadily and quietly, yet with an appearance of life, instinct, and good will, cheerfully perform its task to the sound of the merry mill clack.

The hopper and its attendants are disappearing in modern mills, and a brass receptacle, vainly attempting to imitate a Roman urn, is superseding the only machinery which may be said to have become classical and respected; into this urn the corn descends from above by a pipe fitted into it, and thus the mill-eye is kept closed, as it must be, when an air blast is used. But the hopper had already begun to lose its traditional form of an inverted pyramid of wood, and to

appear as a funnel of sheet-iron, with which the old miller had no sympathy.

The iron apparatus for adjusting and securing the millstones, involved an iron frame and columns to carry it, instead of wood, and hence many mills of recent date have been built fire-proof. For such cases stone foundations and flooring have become requisite, and the mill-spindles, instead of being stepped upon the middle of the foot-bridge, a lever of wood fixed on a joint at one end, and regulated at the other, between the timber uprights carrying the millstone floor, has been brought down to a cast-iron pedestal resting on the masonry, and containing within it a compact combination of wheels or levers and screws, by which the space between the millstones may be altered at pleasure.

It has been proposed to use annular millstones, by removing the central part, where little work is done, and replacing it with a plate of iron leaving the skirt, or as it were a ring of stone; no practical examples of this kind have come under the author's observation, except so far as one of the conical corn-mills partakes of this character, but this must be described separately.

There are three modes of driving millstones at present in use.

The first was suggested by the use of the undershot water-wheel, which, revolving rapidly, required but one increase of speed, and one change of motion from the horizontal shaft to the vertical spindle, and consequently only one pair of wheels, namely, the face-wheel or pit-wheel on the water-wheel axis, and the lantern-wheel or trundle on the mill-spindle; all the machinery being made of wood except the pivots of the axle and the mill-spindle.

This simple, but efficient arrangement, may still be useful in remote settlements, where neither capital nor labour are abundant. It was the usual plan of a mill during the greater part of the last century, and the works of most writers on mechanics and mill-work of the time contain tables showing the number of cogs in the wheel, and staves or rounds in the trundle, to drive a 6-foot millstone sixty revolutions per minute. The cogs and rounds of wood have given place to bevelled wheels of cast-iron, but the principle remains the same. By this means any number of millstones may be placed in a straight line, or in two lines parallel to each other, each millstone requiring a pair of bevelled wheels, one of the wheels (the largest) having wooden teeth,

that they may work more smoothly and with less noise. Mr. Smeaton used this plan for a line of millstones in 1781.

The second method came in with the overshot-wheel, which, going at a slower rate, required the speed to be increased twice between the water-wheel axis and the millstone. So the pit-wheel turned a bevelled pinion fixed on an upright shaft, which formed as it were the centre of the system; on this was also fixed a spur-wheel of large diameter, say from 6 to 10 feet, and round this were ranged in a circle the millstones varying in number with the power of the mill, seldom exceeding six pairs, although small mills had only two. These were driven by the large spur-wheel, by a spur pinion upon the spindle of each pair of stones—any one of which could be thrown out of gear and kept still while the others were at work, by raising up the pinion upon the spindle clear of the spur-wheel, and retaining it in that position by a screw. In the older mills a pair of stones were kept at rest by taking a couple of staves out of the trundle.

The third mode of driving the millstones is by belts; the author first saw it used in a large flour-mill at Attercliffe, near Sheffield, about thirty-five years ago, but it has remained in abeyance until lately, when it has made its appearance, and, copied from the French mills, it is again introduced into this country.

The inconvenience attending this mode, consists in the necessity of placing the belts at different levels when the millstones are placed round a vertical driving-shaft, and in the difficulty of disengaging them when so placed, so as to set any one pair of stones at rest while the others work; and when a line or two lines of millstones are driven from a horizontal shaft the belts are twisted in passing to the vertical spindles, whence there arises a number of practical difficulties—in keeping the belt in its proper place when at work and when at rest, and also in keeping it at a proper tension, so that the strain upon the belt and spindle may be equal, sufficient, and not in excess. The advantages are supposed to consist in the saving of a pair of bevelled wheels to each pair of stones; but as there are three pulleys and a belt substituted for them, the economy is rather doubtful. There must be one broad pulley on the horizontal shaft, and two on the spindle, the one fast and the other loose, or *vice versa*, besides the requisite apparatus for giving the

Fig. 44.

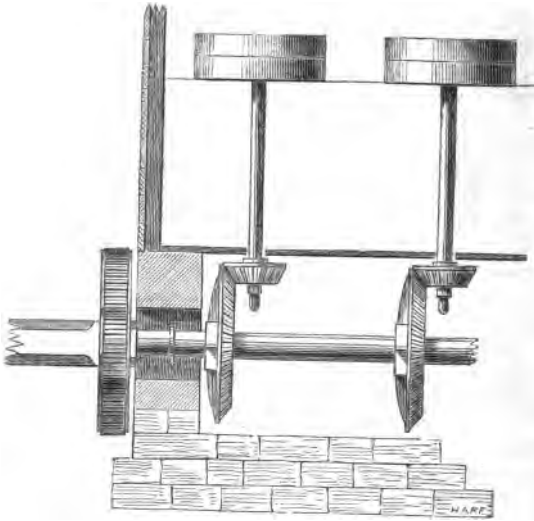

PLAN.

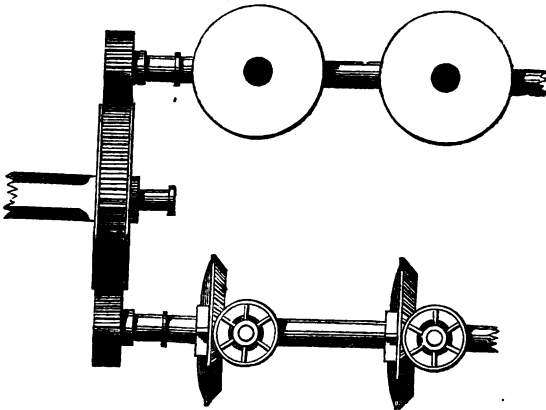
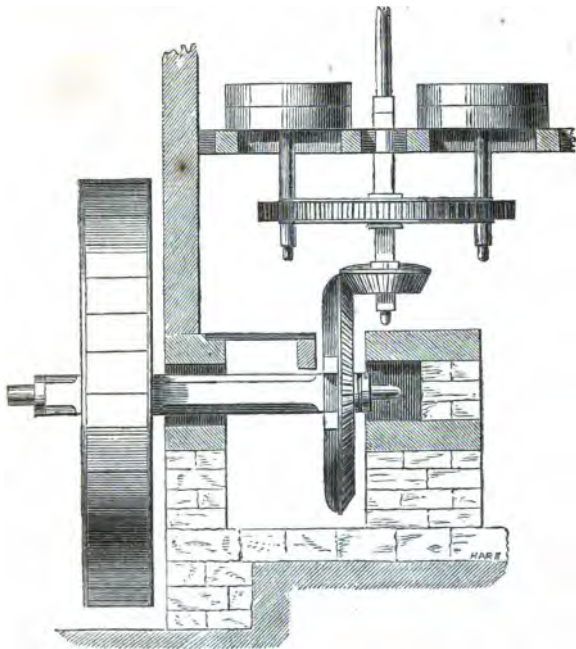
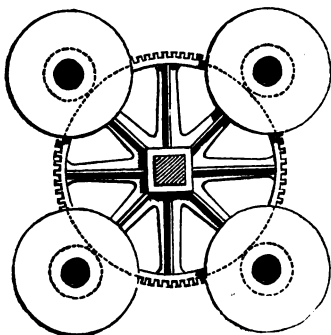

Fig. 45.



PLAN.



belt its proper tension, and means to prevent the neck of the spindle from being drawn to one side by the pull of the belt.

Fig. 46.

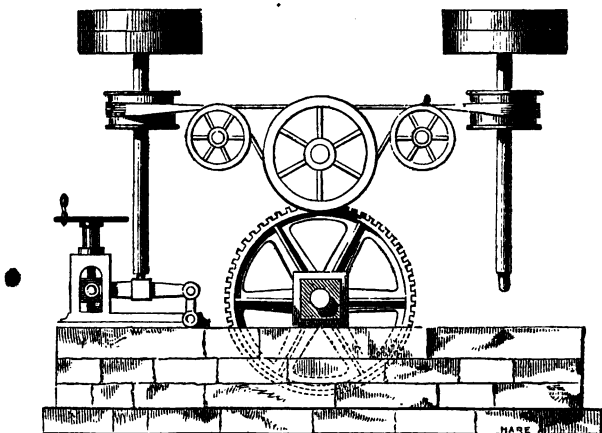

In preparing linseed for the crushing action of the "edge-stones," as used in oil-mills, it is found necessary to bruise the seed between two rollers, like those of a malt-mill, otherwise this edge-stone would be much longer in doing its office, and most of the seed would escape without being crushed at all. Acting on these observations, the French millers have lately adopted rollers to bruise their wheat before it is delivered to the millstones. The bruised corn is much more readily converted into meal than when delivered whole into the millstones, and it is said that by using these rollers both time and money are saved. Since the Exhibition these rollers have found their way into some of the English mills; but as yet the precise results have not been ascertained. In some of these machines there are two pairs of rollers, one above the other; the upper pair bruise the larger grains of corn, and the lower pair take those which pass through the wider space above: the reason for this exactness is, that the wheat may only be bruised, but not broken in pieces, so that the skin or bran may separate easily from the flour when under the millstones.

On leaving the millstones the meal comes down mixed with the skin of the wheat, some in flakes as bran, and some

reduced to smaller particles. It was often made into bread in this state, as wheaten meal; or it was thought sufficient to pass it through a sieve and take out the coarse bran, and when fine flour was wanted it was sifted a second time through a hair sieve, or "*bolting*" through a bag of cloth, woven for the purpose, placed upon a long reel, and turned rapidly round in the bolting or bunting hutch.

The sifting was frequently a domestic operation, performed by the owner of the meal who had his corn ground at the mill, and paid "a multure or toll" in money or in kind; the miller who ground for hire being prohibited by Act of Parliament from buying corn to grind for sale.

Subsequently woven wire was used instead of hair-cloth, and the use of a brush to clear the meshes of the fine sieve, soon introduced *the dressing-mill*, the invention of which was easy, as *the bolting-mill* was already in use.

The reel being fitted with brushes revolved at a high speed in a cylindrical frame or open-work case of wood, 6 or 7 feet long, and 18 or 20 inches diameter, lined with wire-cloth, and placed on an inclined position; the finest wire at the upper end, the size of the wire and meshes increasing towards the lower end, where the bran was delivered. The cylinder was either stationary except when turned round in its bearings by hand, or it had (as an improvement) a slow rotary motion, to bring all parts of the circumference to the top in succession, to keep the wires clear. The motion of the brushes could be reversed, so that by revolving in opposite directions they might wear equally on both sides, and the bristles be prevented from taking a permanent set in one direction; adjusting screws were inserted in the body or axis of the reel to give them the proper pressure against the wires, or to advance the brushes as they wore down. The meal was taken into the head of the cylinder by a "shoe" or spout of wood covered with leather, which was shaken by cams on the spindle, and the enclosed cylinder rested over a series of hoppers to receive the flour of each degree of fineness, as it was driven through the wire-work by the rapidly revolving brushes, generally eight in number. Their speed has been increased since the author first examined these machines, from 320 revolutions per minute to 450; some run 500, and even more, the velocity having of late been much augmented, and the fineness of the wire-cloth also. The wire-work at the upper end of the cylinder being now generally No. 54, that is to

say, 54 wires in a lineal inch, or 54×54 , say 2,916 meshes in a square inch, woven with wire of 34 gauge; some machines have wire-cloth as fine as No. 84, woven with wire of 38 gauge, or 84 wires in the inch, making 7,056 meshes in a square inch; and the Lincoln millers have used wire cloth so fine as No. 92. As the wire occupies two-fifths of the space, the aperture of the mesh is very minute, and the flour dressed through it exceedingly fine, but wire cloth so fine as this is not often used. The wire-work becomes coarser towards the lower end of the cylinder where the bran passes off.

The partitions dividing the hoppers were made moveable on hinges at the bottom, so that their mouths might be widened or contracted in proportion to each other, and more or less fine flour be taken out of the meal, or thrown into the next quality as the customer might desire.

The dressing-mill had now reached its climax, so far as principle is concerned, although many improvements in detail afterwards took place; as, for instance, the substitution of iron for wood, in the case or frame of the cylinder, and the size and inclination of the cylinder itself, which has been increased from 20° to 45° , as the speed has been increased, so as to dress the flour more quickly; for the sooner this operation can be completely performed the better is the flour. The application of external brushes has been introduced to prevent the wires from clogging, and it is found to act beneficially. Attempts have been made (some of them with satisfactory results) to place the dressing-mill quite perpendicular; but the flour falls to the bottom as soon as the centrifugal force ceases, unless prevented by means of shelves or partitions, while the inclined cylinder better admits of the convenient arrangement of hoppers for varying the quality or fineness of the flour, so that there does not appear to be much advantage gained by carrying the cylinder's inclination beyond 45° .

Of late, however, the bolting-mill is again coming into favour. Many improvements have been made in the manufacture of bolting-cloths, which are now woven without a seam, and the French millers having substituted silk for woollen fabrics to dress their flour, the English millers have also adopted them in many instances.

It was not one of the least benefits conferred on this country by the Great Exhibition, that it settled the question with respect to the manufacture of foreign flour. Many

persons thought that the French millers could make flour better and cheaper than ourselves, and the large import of fine flour from France had given weight to this opinion : but the comparison of machinery and means of manufacture exhibited in the French and Belgian divisions proved that on the whole the English miller had no cause for apprehension, although there were many things he might learn with advantage from his neighbours. Time has shown that the export of fine flour from France was chiefly owing to political causes affecting the commerce of the country, which for a period caused the demand for it there to be much lessened, and the price to be so much reduced as to pay for its transport and sale in London, during the unsettled state of Paris.

The corn delivered to the mill by the English farmers is generally well cleaned ; but since the importation of foreign corn in large quantities, which in some instances has lain in heaps on the ground without covering from the weather until it could be shipped, it has become requisite in extensive mills, which manufacture flour from all kinds of corn that may be brought to them, to provide machinery for separating light or damaged grain from the sound wheat, and also to free it from sand and stones.

For this purpose, corn-screens and cleansers of various plans, made of wire or perforated metal, aided by a fan-blast, have been the means employed. The system of washing the corn to free it from impurities and afterwards drying on a kiln, "*la voie humide*," of the French, is not much practised here ; the millers finding the opposite plan, or dry system, "*la voie sèche*," more convenient.

Suppose a vertical cylinder or drum, revolving 280 to 350 times in a minute, covered externally with sheet-iron, pierced with an infinite number of small holes, so that the asperities of their edges project outwards, and placed inside of another cylinder, lined internally with perforated sheet-iron, the sharp edges of the holes projecting inwards with an annular space between them just sufficient to admit a grain of wheat, care being taken that it does not "pearl" or skin the corn. Let the internal drum be about 5 or 6 ft. high, and its diameter about 20 inches. On the top of the drum let there be a fan, with four blades or wings, revolving very rapidly, and suppose the corn to be carried up by the Jacob's ladder and dropped into this fan, it is obvious that all light corn, dust, straw, chaff, and such like things, will

be driven off by the wind of the fan, and that all heavy bodies, as stones, nails, sticks, and the like, will be driven off by centrifugal force, and may be caught in an enlarged part of the case properly designed to receive them; but such particles of earth and grains of bad wheat which are of the same size and weight of good corn fall down with it into the space between the two cylinders, and pass in a spiral direction from top to bottom. In passing downwards, they receive a severe rasping from the two plates of iron, which, like nutmeg graters, break the skin of the damaged corn, and crack the little pellets of carthy matter or sand, in their descent, and also cleanse the corn of sprouts, beards, and other protuberant excrescences. At the bottom is another fan, which separates the dust, smut, and other light matters rubbed off the grain, which being caught and retained, the corn passes into a slightly inclined cylinder or cribbling machine, about 20 inches in diameter and 12 or 13 feet long, covered with smooth plates full of small holes, and by it all things smaller than a grain of wheat, but of the same specific gravity, which the two fans had failed to separate, are taken out of the corn,—larger things of equal weight having been grated down by the drum, and heavier things driven off by the fans.

When there is plenty of good water and plenty of room, the humid mode of treatment has its advocates, and they have many good reasons to advance. The author well remembers, many years ago, visiting the mills of Mr. Pilling, at Mirfield, near Bradford, Yorkshire, who very successfully treated his corn in this way. His mode of drying it was peculiar. Suppose a building three stories high; and on the ground-floor a stove or cockle, such as is used to dry yarn, consisting of an iron chamber or oven, with a fire-grate in the bottom of it, enclosed in another iron case, leaving a space of 15 or 18 inches between the two on every side, so that fresh air could pass through and be heated: by the side of this cockle was placed a powerful fan-blast to drive the air through this space, which being heated as it passed, went up through the floor above, and filled a low room or chamber, made air-tight or nearly so: this room was only about five feet high between the floors. The first floor was laid with Yorkshire pavers on cast-iron joists, and the second floor was laid with perforated kiln plates pierced with an immense number of small holes cast in them. This was a lofty room with a cowl, like a malt-house, and upon

this floor was spread the wheat to be dried, through which the hot air, urged by the action of the fan, found its way.

This arrangement was not only found to be very useful in drying corn after it had been washed, but it was also very beneficial in drying corn that had been exposed to wet on the field, and prevented it from spoiling, as well as in giving the requisite degree of dryness which millers prefer. The extreme hardness and dryness of much of the Italian wheat, and the produce of some parts of the south of France, render the corn, unless it be moistened to make it "grind kindly," apt to splinter and break, like ground rice, rather than to flag out into meal, when the flour and bran readily separate.

The corn being treated in the dry or the humid way, if it require either, or if it be clean English wheat carefully dressed and winnowed by the farmer, it is brought to the proper shoots to be delivered into the millstones and ground, by means of the endless screw and the Jacob's ladder, or in mills of less size and pretension it is shot from the sack by the miller as he wants it.

When the wheat arrives at the mill, in the barge or the farmer's waggon, it is hoisted up by the sack-tackle—a very simple but ingenious machine, which ought to be much more generally used in all places where merchandise is to be lifted and loaded or warehoused.

Let us return to the mill driven by spur-gear, with a vertical shaft in the centre, extending from the bottom of the mill to the top. On the upper end of the vertical shaft is fixed a horizontal wheel, bevelled on the face and clad with wood fitted into it endways and turned smooth: against this works another wheel made in the same way (without teeth in either of them), but the grain of the wood being at right angles with the faces of the wheels; the two, when brought in close contact by means of a compound lever, *bite* together with sufficient adhesion to hoist a sack of wheat or flour. This contact is produced by the miller pulling a cord attached to the lever, and the wheels are brought forcibly together; the upright shaft always revolving while the mill is going, but the other wheel, which carries a roller and a chain, revolves only when the cord is pulled and while the two wheels are kept in contact.

The miller makes a noose with the ring at the end of the chain, tackles the sack, and pulls the cord; the wheels are brought into contact, and the sack ascends, opening the

trap-doors in each succeeding floor, which again close as it passes through them, until the sack attains the required height, when he ceases to pull the cord, and lands it. In like manner, when he wants to lower a sack of flour into a barge or waggon, he tackles it with the noose, and lifts it by pulling the cord, then shoves it off, and preventing acceleration by an occasional and dexterous pull of the cord, he drops it into the hands of the bargeman or waggoner, who guides its fall into the proper place.

Such is a brief outline of the mechanism of a corn-mill, whether driven by water or by steam; the windmill is fast disappearing from the rural landscape, and the author regrets the annihilation of one in which, when a boy, he spent many a pleasant hour; but surrounding buildings took the wind out of its sails, "and its destiny was accomplished."

Let it not be supposed by the readers of the present day that the author writes of times long past: he writes of his own time. "When George the Third was King," every Parliament was occupied in framing regulations respecting flour and bread, and most men of middle age remember when everything relating to flour and bread came under the cognisance of the magistrates, who fixed the price of the quartern loaf and the size of the penny loaf.

By the 36 Geo. 3, cap. 85 (1796), "Every miller shall keep balances and weights according to the standard of the Exchequer, and in default shall forfeit twenty shillings. Millers are to deliver the whole produce of corn when ground if required, allowing for waste on grinding and dressing, and for toll when taken; and if such corn shall weigh less than the full weight, such miller shall, for every bushel of corn deficient in weight forfeit a shilling and treble the value of such deficiency. When toll is taken, it shall be deducted before the corn is put into the mill, and no miller shall demand corn for toll under penalty of five pounds, except when persons shall not have money to pay for grinding. Every miller shall put up in his mill a table of the amount of such toll or multure, or forfeit twenty shillings for each offence, but this shall not extend to mills called 'Soke mills,' or to such ancient mills as are established by custom and the law of the land, which mills shall continue to take toll as they have been accustomed to do."

The inhabitants of two of the largest manufacturing towns in England are still compelled to have their corn

ground at the "Soke mills," and to eat no other bread. Leeds and Wakefield have risen rapidly in population and wealth, but when they were small communities, they petitioned their lords to build them mills, and in return bound themselves and their successors for ever to grind their corn there—an obligation which, in these days of free trade, they would gladly cancel if they could. There are other places in the same condition, but they are content to give "the lords' mill" the preference to which it is by law entitled, so long as the lord of the manor will grind at market-price, without resisting his lordship "upon principle." Yet it is not to be supposed that such privileges, or even the toll taken by the miller, passed unquestioned or unresisted, for the 41 Geo. 3, c. 24, enacts that the damages occasioned by demolishing a mill by persons riotously assembled may be recovered in the manner prescribed by statute, respecting the demolishing of churches and other buildings; while the 43 Geo. 3, c. 58 (1802-3), enacts that any person who shall maliciously set fire to any mill in the possession of any other person or of any body corporate, shall be guilty of felony, and suffer death without benefit of clergy.

Mr. James Watt, at a late period of his life, thus writes: "The mention of the Albion mills induces me to say a few words respecting an establishment so unjustly calumniated in its day, and the premature destruction of which, by fire, in 1791, was not improbably imputed to design. So far from being, as misrepresented, a monopoly injurious to the public, it was the means of considerably reducing the price of flour, while it continued at work.

"It consisted of two engines, each of fifty horses' power, and twenty pairs of millstones, of which twelve or more pairs, with the requisite machinery for dressing the flour and for other purposes, were generally kept at work.

"In place of wooden wheels, always subject to frequent derangement, wheels of cast iron with the teeth truly formed and finished, and properly proportioned to the work, were here employed; and other machinery, which used to be made of wood, was made of cast-iron of an improved form; and I believe the work executed here may be said to form the commencement of that system of millwork which has proved so useful to the country.

"In the construction of that mill-work and machinery, Boulton and Watt derived most valuable assistance from that able mechanic and engineer, Mr. John Rennie, then

just entering into business, who assisted in planning them, and under whose direction they were executed.

“The engines and mill-work were contained in a commodious and elegant building, designed and executed under the direction of the late Mr. Samuel Wyatt, architect.”

Such was the fate of the first great steam-mill erected in London little more than sixty years ago, in which the talents of Watt and Rennie were combined. The year 1852 has witnessed the completion of an undertaking—“The City Flour Mills,”—which may be termed a flour manufactory rather than a mill, built near Blackfriars Bridge, and within sight of the spot where the “Albion Mills” were erected—an enterprise which, if successful, as it promises to be, will effect great changes in this branch of industry.

The present cotton mills in Manchester are scarcely more unlike the old system of hand-spinning, than is this building as compared with the picturesque water-mills we were accustomed to see in our young days. It has two engines working together on one shaft; they are large “steam-packet” engines, each of 125 horses’ power, or, together, 250. There will be 60 pairs of millstones, all of them 4 feet in diameter, and making about 128 revolutions per minute; the upper millstones have hollow backs, and a blast is sent into them; thence it passes through the eye and through holes in the top stone; the air quickens the grinding, and makes the stones work cool. The millstones are placed in two rows, one against each side wall, on one floor. The flour is received in covered metal troughs, in which endless screws work the meal along into boxes, to be carried away by the Jacob’s ladders or elevators.

The dressing-machines are hexagonal, and are covered with silk; they are 3 ft. 4 in. in diameter across the angles, and 34 ft. long, and have a slight inclination, about 20 inches in their whole length, and are driven at about 28 or 30 revolutions in a minute. The shafts of these machines are hollow, and have also holes through them; but the lower half of the shaft is closed; a blast is driven into the upper end of the hollow shaft, and blows through the holes into the inside of the dressing-mill, for about half its length, and through the silk, so that it cools the flour, cleans the silk, and quickens the action of dressing.

There are some wire machines for brushing the bran, but all the flour is dressed through silk, the chief object being to make fine flour. There are, besides corn-cleansers, also

with a blast, somewhat like those already described, and sack-tackles, worked by belts, many of which are double-acting, at every point where they can be made useful, so that manual labour may be economised at every stage of the work by the intervention of mechanical power.

All the millstones and most of the machines are driven by belts, which lessen the noise considerably, and much ingenuity is displayed in their application to prevent lateral stress on the necks of the mill spindles and to obviate the other objections to belts before mentioned: the spindles are long, and have no foot-bridges, each being stepped on a

Fig. 47.

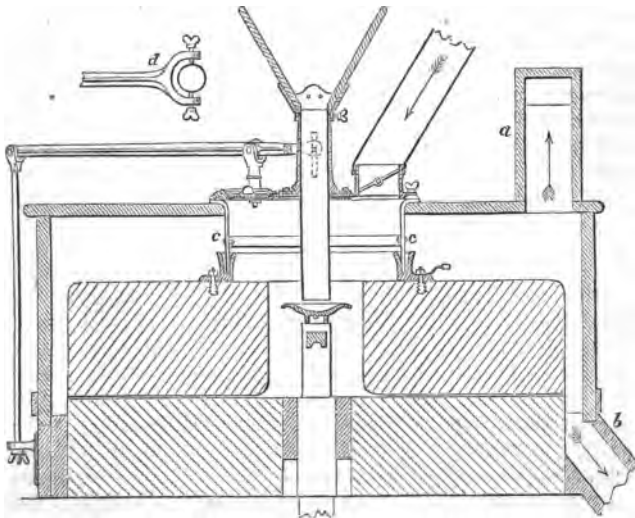

- a* The waste air trunk carrying up the dust or stive.
- b* The meal spout.
- c* Collar or ring of leather to confine the air brought in by a flexible pipe.
- d* Forked end of the lever to regulate the supply of corn to the millstones. The arrows show the course of the air.

hollow pillar, containing a regulating screw, and the upper stones are hung, like a mariner's compass, on gymbal rings, and carefully balanced: so that altogether it may be said this is a *flour factory* rather than a corn-mill; and in order

that nothing may be wasted, exhausting-fans are applied to the millstone cases, producing a slight draft of air sufficient to collect and deposit in a proper chamber, the dust, or "stive," as millers call it; but not strong enough to carry up the meal. This also keeps the mill cleaner, and the stive, which is finer than flour, can be made useful. The author is much indebted to Messrs. Swayne & Bovill, who have designed and erected the machinery of this mill, for their readiness in affording him information and access at all times to this magnificent establishment.

Mr. Bovill proposes to apply blowing and exhausting fans to ordinary millstones already in use, without making holes through them, by sending the current of air through the millstone eye to be discharged at the circumference, and to collect the dust or "stive" from the millstone cases by the exhausting-fan, and prevent its flying about the mill, carrying it up through an air-trunk, and discharging it into a chamber of lattice-work lined with bunting or some similar thin woollen cloth, permitting the air to escape, but retaining the dust. The annexed woodcut shows the proposed arrangements. (See fig. 47.)

CHAPTER XIII.

THE CONICAL MILLS.

OF the conical corn-mills exhibited in the Crystal Palace, there were two which more particularly claimed attention. One of these was a cone, or rather a conoid of stone of peculiar form, base upwards, which fitted, or nearly so, into a block of stone hollowed out to receive it, and in which it revolved, like the ancient "*quern*," or like the old mill found at Pompeii reversed; for in that antique mill, the cone or conoid stood fixed upon its base and the stone casing revolved, but in this modern adaptation, the case is fixed and the conoid turns.

The form given to this millstone was also recommended by the exhibitor as applicable to the pivots or steps of upright shafts, screw propellers, turbines, and other mechanism where the revolving surface must resist vertical weight or end thrust.

The inventor proposed to exhaust the air from below the millstones by means of a ventilator or fan, and thus to draw down a current between the stones to keep them cool. There was much ingenuity displayed in various contrivances about this mill and its adjuncts; the trouble and incon-

Fig. 48.

MR. SCHIELE'S MILL.

RULER

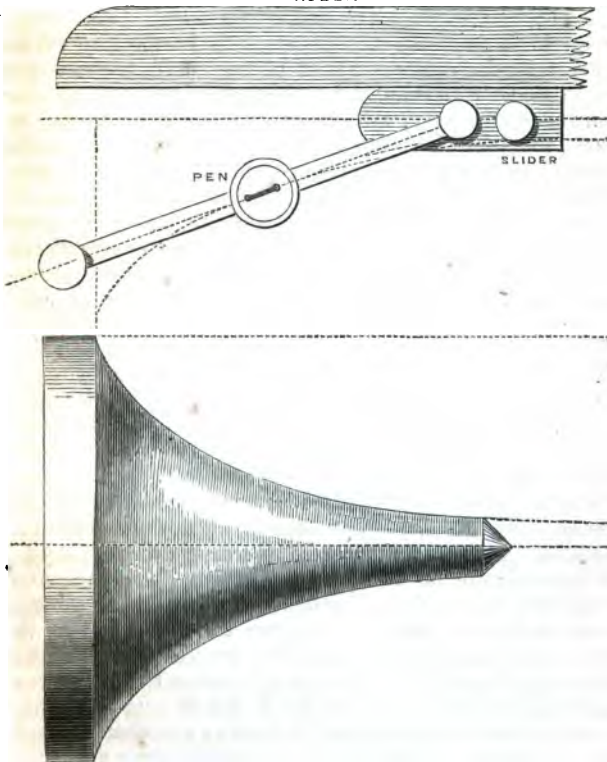

Mode of striking the curve to form the millstone or pivot.

venience occasioned by the cutting and heating of steps and pivots subject to end pressure, even in an ordinary lathe, are well known, and should the mill itself not prove so

successful in practice for grinding corn as the inventor expects, it may answer well in grinding painters' colours; the form of step he recommends may in many cases be useful to lessen the friction of machinery. Mr. C. Schiele of Oldham, near Manchester, is the proprietor of this mill, and the curve he has adopted is one discovered by Huygens, in his investigation of the cycloid. It is one of those singular and beautiful curves called "tractories," and in this case it is produced by drawing the centre point of a radius bar along a straight line, which is the axis of the curve. The radius bar carries a pen, the nib of which is in the line of the radius. At the commencement of the curve, the radius is at right angles with the axis, but the radius bar, turning freely upon the centre point, as it is drawn along the straight line or axis, the angle it makes with this line varies continually, becoming more and more acute like the tangent of a catenary or a parabola. Dr. Peacock has shown that the mechanical tractory of a straight line, upon a perfectly smooth plane, is an inverted semi-cycloid; but, in this case, the retardation produced by the pen and paper causes the curve to be infinite, and from its peculiar properties it has been termed "the equitangential tractory." (See fig. 48.)

The conoid is formed by this curve revolving on its axis.

The other conical flour-mill, which deservedly attracted much notice in the Exhibition, was the invention of Mr. W. Westrup, a practical London miller. It differed entirely from any other flour-mill hitherto used, and the author availed himself of all the opportunities the display in the Crystal Palace permitted to examine its mechanism and arrangements; he has since seen it at work, and also in pieces, the proprietors liberally affording every facility for the inspection of all the parts in detail. Each mill, so to speak, has two pairs of millstones combined, working together, the one pair placed above the other, so that the upper pair commences the grinding process, and the lower pair completing it; there is a space between the two pairs of millstones about 27 or 30 inches in height, and the greater portion of this height or space is used as a vertical dressing-mill, the spindle which drives the stones being fitted with brushes, and the space inclosed with a cylindrical screen of fine wire-cloth mounted on a frame in the usual way. The upper millstones are fixed, and the lower stones revolve, and both the upper and lower stones are placed upon one spindle. The upper stones are each made in two parts, or

semicircles bolted together, for convenience of fixing and displacing when needful, and they are capable of adjustment by means of fixed wedges or inclined planes, on which they rest, so that by the action of a screw and wheel a partial horizontal turn or twist of either of the upper stones, causes it to slide up or down on these bent wedges or inclined planes which are placed round the circumference of the stone. It is thus raised or lowered, and the grinding space adjusted with great facility. The lower millstones, which revolve, are convex, and the upper stones concave and annular; for the stones being of small diameter the eye of the stone is large in proportion. The diameter is about 2 feet 6 inches, and the grinding surface on each side of this ring of stone 8 or 9 inches broad; the rise or bevel of the cone in that width is about 4 inches. The stones being small, necessarily revolve rapidly, say about 250 revolutions per minute, and the spindle being hollow from the top, a pipe is fitted into it by a swivel-joint, and a blast of air driven by a fan is carried down the spindle, which is closed at the lower end, and distributed through holes in the running stones into the grinding space, so that the meal is immediately blown out, and the grinding surfaces kept clear. The finest flour is brushed through the wire-work of the vertical cylinder, and received in a casing of wood. The larger particles and portions of the corn imperfectly ground, pass into the lower pair of stones, and are reduced into meal ready for dressing in the ordinary way.

As by this arrangement of parts the corn cannot be delivered into the centre of the upper millstones, a hopper or chamber is placed on one side, with a sliding tube or feed-pipe in the top of it, and an upright spindle carrying a dish, which revolving quickly, evenly distributes the corn. This description will probably enable the reader to understand the annexed engraving, which is copied from a section obtained from the inventor. (See fig. 49.)

The manner in which this mill does its work is very satisfactory. The corn is so short a time in passing through it, that the bran is delivered in large flakes, many of them nearly the entire skin of the wheat, and the grinding being so quickly done the meal comes away comparatively cold. The fine flour driven through the intermediate dressing-case is the heart or kernel of the wheat, and is suited for pastry or confectionary.

There is a vertical dressing-mill separate from the mill-

Fig. 49.

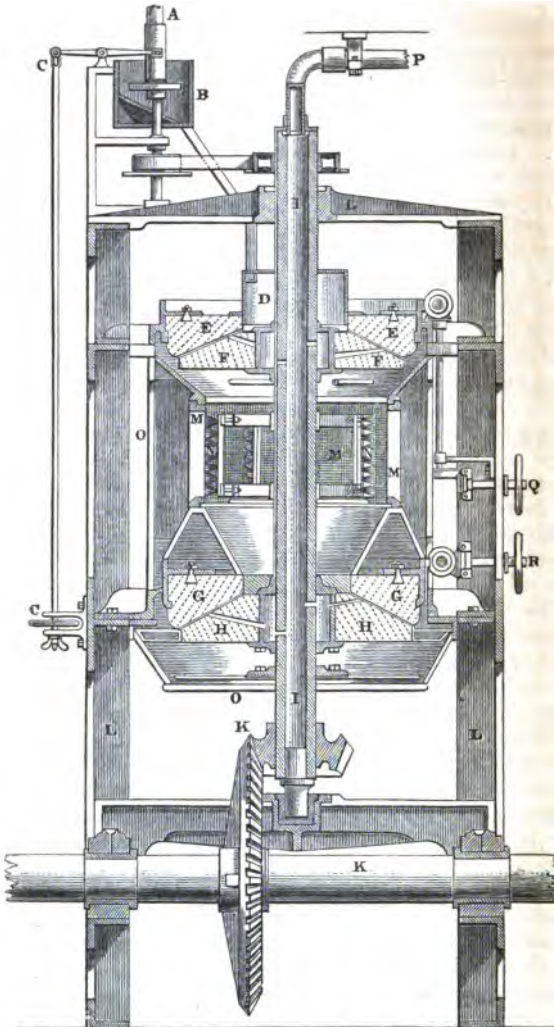

WESTRUP'S CONICAL MILL.

References to Mr. Westrup's Conical Mill. (See Woodcut.)

- A, Feeding-pipe to supply corn to the millstones.
- B, Apparatus to regulate the supply.
- C, Regulating lever to adjust the same.
- D, Chamber over the eye of the millstone to receive the wheat from the regulator.
- E, Top stone in the upper pair of millstones which in this mill is stationary.
- F, Nether stone of the upper pair which in this mill revolves.
- G, Top stone (stationary) of the lower pair.
- H, Nether stone (runner) of the lower pair.
- I, Hollow spindle on which the runners or revolving millstones are hung.
- K, Bevelled wheels and driving-shaft.
- L, Iron framework sustaining the whole machine.
- M, Upright wire cylinder acting as a partial dressing machine.
- N, Revolving brushes acting against the wire.
- M, o, Wooden case enclosing millstones and wire cylinder, to the bottom of which the spout for the meal is fixed.
- P, Pipe to convey cold air to the faces of the millstones by means of the hollow spindle.
- q, Regulator for adjusting the upper pair of millstones.
- R, Regulator for adjusting the lower pair.

stones, in which the flour is finished for the market, and there has been much ingenuity exercised in contrivances to obviate the inconveniences incident in general to the perpendicular cylinder. The axis carries a series of shelves or tables, which in succession receive the meal and scatter it by their centrifugal action; but it is questionable whether any real advantages are obtained by carrying the inclination of the dressing-mill beyond the angle of 45 degrees, for at that angle, with a high speed for the brushes, the meal must describe a spiral track of several revolutions in traversing the length of the cylinder, and the adaptation of hoppers, with moveable partitions before described, is of great practical convenience.

The inventor of this conical mill has induced several gentlemen to join him in order to carry out his plans to a greater extent than he could hope to do individually, and to form themselves into a joint-stock company. They entertain, in many respects, similar ideas on the manufacture of flour with the proprietors of the large steam-mills already noticed, namely, that flour, like cloth, is a manufactured article of general consumption, and that by manufacturing on the

large scale, with machinery to do the work, and men to direct its operations, rather than to labour in the mill, they shall be able to supply the flour to the consumer at a lower price with a fair profit for themselves; they also think that the inventions of Mr. Westrup will better enable them to realise their views, and it is but right to say, that several persons have embarked in this undertaking—"The Conical Flour-mill Company"—who are known as men of experience and skill in this branch of industry.

These gentlemen say—"It is scarcely necessary to observe that the vast resources of England during the last fifty years have depended on her improved machinery. It has indeed been said with equal truth, that her independence as a nation rests upon her being twenty years in advance of her neighbours. And never was it more necessary to maintain such pre-eminence than at this time of great struggle, when the importation of wheat and flour has been made free to all nations, before the agricultural and milling interests, and the large capital invested in them, have been prepared to meet the competition of the world. Thus it is that improvements in these important departments of British industry are now more especially occupying the serious attention of some of the first minds in the kingdom—from the prince to the peasant—as a necessary requirement for their profitable continuance."

The author hopes that the circulation of this little volume may stimulate inquiry and research among the practical and operative men into whose hands it may fall; and that the facts and circumstances which have rather been indicated than described, may form as it were the text, which in more able and experienced hands may be amplified and illustrated. The work has been hastily written at intervals, when the author could spare a short time to add a few pages or to note down a few observations as they might occur, without much opportunity of arranging them afterwards.

This will be apparent to all who may read this book, and it will also be noticed, that the words of the authors quoted throughout the volume, are generally given as they were found, in the phrase of their own style and time, so that the lesson may be learned as they taught it. It has been exceedingly gratifying to the author, and he has much pleasure in acknowledging it, that whenever he has had occasion to verify a fact, to correct a statement, or to ask information, he has, in every

instance, been met with the greatest frankness and candour, and every question asked has been fairly answered—some by letter, and some personally. It is difficult to mention names when so many persons have been referred to and all have acted alike, yet he feels he should be ungrateful to the following gentlemen did he not acknowledge the obligations he is under. He has especially to thank Messrs. Ransome & May, of Ipswich, well known as manufacturers of agricultural implements, and of machines for cleansing and dressing wheat; Messrs. Bryan Corcoran, and Co., of Mark-lane, importers and makers of millstones and grinding machinery; Messrs. W. Mountain & Sons, of Newcastle-on-Tyne, celebrated for their wire-work and dressing-mills; Messrs. Swayne & Bovill, the millwrights of the City Flour Mills; Mr. Westrup, the inventor, and Mr. Middleton, the manufacturer of the conical corn-mill; Mr. Armstrong, the inventor of the hydraulic crane, and maker of the water-pressure engine; Messrs. Easton & Amos, manufacturers of the improved water-rams; and many other gentlemen.

In writing this treatise, the works of Smeaton, Hutton, Sir Robert Kane, and Mr. Beardmore, and the papers of Mr. Blackwell, Mr. Rennie, MM. Morin, Poncelet, Piobert, Coladon, and other foreign engineers, have been quoted, and the Transactions of the Royal Society, the Institution of Civil Engineers, the Society of Arts, the British Association, the Professional Papers of the Royal Engineers, and other records consulted. In all of those above-named the reader will find much information and many valuable experiments in detail; but to do justice to the subject which forms the concluding part of this little book, *The Progress of Corn-mills, and the Development of their Machinery*, would require a large and amply illustrated volume, rather than a simple rudimentary treatise on the means of preparing the staff of life for the support of man.

APPENDIX.

CENTRIFUGAL AND ROTARY PUMPS.

In the preceding pages the reader will have observed that several machines derive their power from the reaction of water-pressure : such as Dr. Barker's mill, Whitelaw's mill, the Vortex-wheel, and others. If these machines be impelled by some other power, and caused to revolve by an equal external force, say that of a steam-engine, they may be made to act as pumps ; and as they had before been put in motion by the pressure of a column of water descending and passing through them, they would, by inverse action, raise a corresponding column of water to the like height.

Let the most simple of these machines, Dr. Barker's mill (fig. 15), be turned upside-down,—let the funnel mouth at the top, there shown as receiving the water, be immersed in a well, and the machine caused to revolve rapidly on its axis ; the swift-rotary motion will cause a partial vacuum in the arms, and the water will rise in the central pipe and fill them until it is thrown out at the holes near the ends, where the centrifugal force will cause continuous streams to be discharged so long as the requisite velocity is maintained.

The straight form of the arms, however, causes a considerable loss of effect : the course the water should take is that of the curve compounded of its radial direction, and of the rotary motion of the machine, for any radial velocity in the water, at the point of discharge, is power uselessly expended. Another centrifugal machine, having the same diameter, section, and apertures, but having the arms bent to the proper curvature, will discharge more than double the quantity of water in the same time with the same power—(see figs. 18 and 20). This was proved by direct experiments made by Mr. Hensman, at the request of the jury, during the Great Exhibition.

Thus Mr. Whitelaw's mill will be found to make a very effective machine for raising water, by reversing its action ; and hence it was that the jury found Mr. Appold's wheel, formed with vanes similarly curved, produced so much greater results than wheels of the same dimensions with straight vanes. Mr. Appold's wheel was only 12 inches in diameter ; it received the water on each

side, through apertures of 6 inches diameter, and had a central disc or diaphragm perpendicular to the axis, intersecting the vanes, forming, as it were, a double wheel revolving between two cheeks that projected from opposite sides of the reservoir.

The vortex-wheel (fig. 25), perhaps, may serve to explain the form and operation of Mr. Appold's pump, by supposing the axis to be horizontal, and the water to enter at the sides and be discharged through the large round pipe. When this wheel was tried against two others of the same size, the one with straight arms or vanes, inclined at an angle of 45 degrees, and the other with radial arms, the following results were obtained :—

	Revolutions per minute.	Gallons raised per minute.	Height raised.	Useful effect.
Mr. Appold's wheel .	792	1164	18 ft. 8 in.	·649
" " " . . .	788	1236	19 " 4	·680
Inclined vanes " . . .	694	560	18 " 0	·394
" " " . . .	690	736	18 " 0	·434
Radial vanes . . .	624	369	18 " 0	·232
" " " . . .	720	474	18 " 0	·243

The experiments were made under the direction of Colonel Morin, and the amount of motive power employed was ascertained by the dynamometer, constructed by M. Morin, on a principle proposed by General Poncelet.

The author was present during some of these trials, and was gratified to witness the care and skill with which they were conducted.

By admitting the water at both sides, the atmospheric pressure is neutralised and balanced ; this is not the case in Whitelaw's arrangement, although a similar method has been used in other machines, as in the " Fan-Blast," for blowing furnaces and forges, several of which of large size have been constructed by the author, and machines, similar to the rotary-fan, have also been applied to raise water.

During a long practice in the drainage of extensive tracts of Fen and Marsh lands, by steam-power, where natural drainage was impracticable, the author employed *Scoop-Wheels* to throw off the water. These were like the Breast-wheel reversed, and the reader may imagine their action by referring to fig. 29, and supposing the wheel to lift the water, instead of being turned by it. Two wheels like this, 28 feet in diameter, driven by steam-engines, were constructed by the author, at the Butterley Iron-works, some years ago, for the drainage of Deeping Fen, near Spalding, containing about 25,000 acres, then often covered with water, but now growing corn. One of these is found sufficient, except in very rainy seasons, to keep the Fen clear of water. It is turned by an engine of 80 horse-power, and the floats, or

ladle-boards, travel at a mean rate of 6 feet in a second: these measure $5\frac{1}{2} \times 5$ feet, and deliver a constant stream of water, with a sectional area of $27\frac{1}{2}$ square feet, which moving at the speed abovenamed, discharges 165 cubic feet, equal to more than $4\frac{1}{2}$ tons of water in one second; or about 16,200 tons in an hour. A more simple or effectual mode of raising a large body of water to a height of ten or twelve feet (from surface to surface) cannot well be devised, nor one less liable to derangement, from ice, weeds, and drift-wood. By this means upwards of 125,000 acres of Fen-land in England have been cleared of water under the author's direction, besides similar works of drainage in Holland, Germany, and in British Guiana, where the same machinery also irrigates the land in the dry season. For the drainage of small districts, it is probable that rotary or centrifugal pumps may be used with advantage. The number and variety of these machines, exhibited at the Crystal Palace, in 1851, and the elaborate and valuable experiments then made, have afforded data for their construction and improvement, which will tend to make their application to such purposes more general, and prove one of the many benefits resulting from that ever-memorable display of industry and ingenuity.

THE END.

LONDON

BRADBURY AND EVANS, PRINTERS, WHITEFRIARS.



